



NICE UPTIVITY SURVEY FOR TDM ENVIRONMENTS

March 2017

www.incontact.com

NICE UPTIVITY SURVEY FOR TDM ENVIRONMENTS

Version: This guide should be used with NICE Uptivity (formerly inContact WFO Premise) v5.6 and higher.

Revision: March 2017

Copyright: ©2017 inContact, Inc.

Contact: Send suggestions or corrections regarding this guide to documentationsrequest-discover@incontact.com.

Table of Contents

Introduction.....	7
Audience	7
Goals.....	7
Assumptions	7
Need-to-Knows	7
Product Technical Overview.....	9
Requirements.....	11
PBX	11
TDM/ISDN-Supported PBXs	11
Hardware, Software, and Licensing.....	11
NICE Uptivity Survey	11
Hardware	11
Software and Licensing	11
Performance Considerations	12
Performance Guidelines.....	12
Beep Tone	12
Uptivity Survey Call Linking	12
AudioCodes Configuration.....	15
Wiring Example.....	15
Configure the Ai-Logix Card.....	16
Verify Ai-Logix Card Operation	17
 NICE Uptivity Survey for TDM Environments	 3

Introduction	
PBX Configuration	18
Configure DNIS and ANI	18
Configure UCID for Uptivity Survey Call Linking	18
Install and Configure Uptivity Survey	20
Windows Server Tasks	20
Install the Uptivity Survey Server Software	20
Register Uptivity Survey as a Windows Service	20
Configure the Settings.INI File	21
Add Uptivity Survey as an Allowed Application	22
Install Default Files	22
Web Portal Tasks	23
Add the Application to the Uptivity Service Manager	23
Enable Uptivity Survey Score Column in Call Lists	23
Uptivity Survey Call Linking (Optional)	23
Install the Uptivity Survey Linking TSAPI Script	24
Configure the Settings.INI File for Uptivity Survey Linking	24
Post- Survey Linker (Optional)	26
Configure the Post-Survey Linker INI File	27
Register Post-Survey Linker as a Windows Service	29
Add the Application to the Service Manager	29
Security	29
Permissions	29
Auditing	30

Encryption	30
Archiving	30
Uptivity Survey Administration	31
Manage DNIS Values	31
Configure DNIS Values	31
Import Multiple DNIS Values	31
Specify Uptivity Survey Audio Directory Settings	32
Survey Forms Listing	33
Create Survey	34
Question Types	37
Threshold Branch Example	38
Search Attempted Surveys (Form Search)	40
Uptivity Survey Reports	41
Survey Detail Report	42
Survey Detail Summary Report	43
Survey Overview Report	43
Survey Summary Report	44
Survey Summary by Agent Report	45
Survey Summary by Question Report	46
Survey Summary by Response	47
Appendix: PBX Configuration Examples	50
Avaya	50
DS1 Circuit Pack	50

Introduction

Trunk Group Configuration	51
eOn eQueue	53
T1 Line Assignment	53
T1 Class	53
Port Class.....	54
ISDN Group.....	54
ISDN Parameter.....	55
Hotline	55
Nortel (Avaya)	56
Document Revision History	57

Introduction

Audience

This document is written for supervisors, managers, and administrators at organizations that use NICE Uptivity Survey in traditional, wired telephony (TDM) environments. It is also written for installation and support engineers at both inContact and our partner organizations who install Uptivity Survey. Readers should have a basic level of familiarity with general networking, usage of a PC and its peripherals, the Windows operating system, their telephony environment, NICE Uptivity, and survey theory.

Goals

The goal of this document is to provide knowledge, reference, and task information necessary for installation, management, and use of NICE Uptivity Survey.

This document is NOT intended as a specific system or network design document. The guide also does not cover the NICE Uptivity services and components necessary for recording, PBX integration (such as CTI Core and Voice Boards), quality management, and so forth.

Assumptions

This document assumes that if your organization is using NICE Uptivity for recording, QM, and so forth, you and your Uptivity team have deployed and confirmed that the software is working correctly.

Need-to-Knows

📌 NICE Uptivity Survey is managed from the Uptivity Web Portal.

NICE Uptivity allows administrators to customize field names and terminology in the Web Portal to fit your unique environment. Therefore, screen examples and field names used in this manual may differ from those seen in your implementation.

Tasks described in this manual may be limited by permissions. If you need to perform a task and are unable to do so, see your supervisor or NICE Uptivity administrator.

Introduction

Several NICE Uptivity features use menus and other windows that may be considered as “pop-ups” by some browsers. inContact recommends that you configure your browser to allow pop-ups for the Web Portal.

NICE Uptivity supports standard Windows methods for selecting multiple items in a list: press and hold the **[Shift]** key while clicking to select consecutive items or press and hold the **[Ctrl]** key while clicking to select non-consecutive items.

In some cases, NICE Uptivity provides more than one way to accomplish a task or access a feature. The procedures in this manual explain the primary method, but also note the **Alternative** where applicable.

Product Technical Overview

This diagram illustrates the NICE Uptivity Survey components and interactions. The accompanying table provides additional information about the components.

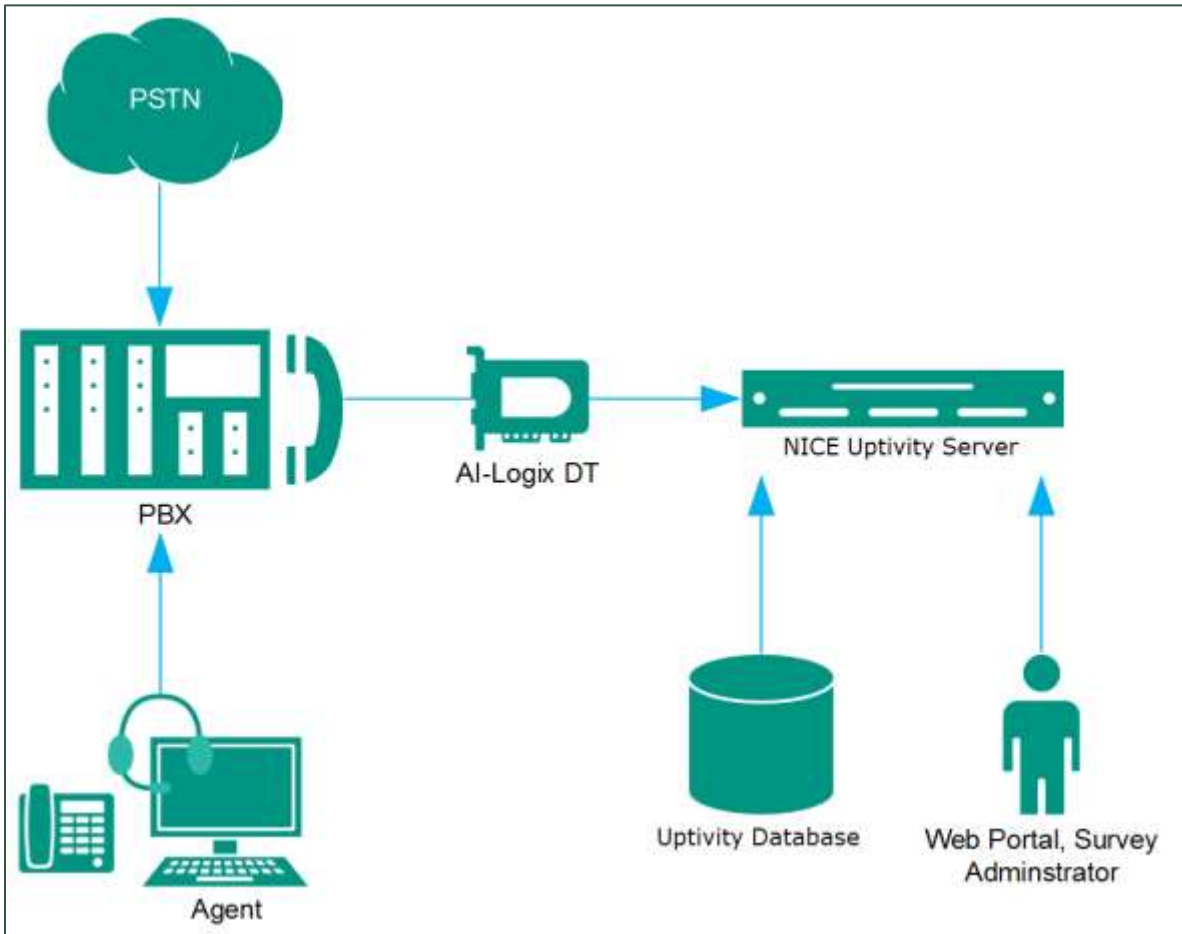

Component	Function
<p>Callers via PSTN or Agents</p>	<p>Uptivity Survey can be configured to handle calls three ways:</p> <ul style="list-style-type: none"> • A telephone number can be set up and provided to the public. Callers dial the number, and the PBX directs the call to the survey engine. • Agents transfer callers to the survey engine via the PBX. • Agents terminate a call and caller is automatically transferred to a survey (dependent on PBX capabilities and configuration).
<p>PBX</p>	<p>A unique DNIS is created on the PBX for each survey. The PBX transfers calls from agents or toll-free numbers to the appropriate DNIS and survey.</p> <p>For each call, the PBX can send the survey engine the:</p> <ul style="list-style-type: none"> • DNIS • Caller number or Agent/Extension number as an ANI
<p>Ai-Logix DT Audio Capture Card</p>	<p>Uptivity Survey connects to the PBX/ACD via a direct cable connection between a T1 trunk and the DT card in the Uptivity Survey server.</p>
<p>Uptivity Survey Server</p>	<p>Uptivity Survey consists of the survey engine that executes the survey forms and audio files, writes responses and call information to the database, and records respondent voice comments to WAV files.</p> <p>The directories for survey forms, audio prompts, and verbal response files are located on this server in most installations, although they can be located on a different server.</p>
<p>Uptivity Web Portal</p>	<p>Administrators, system administrators, and managers use the Web Portal to:</p> <ul style="list-style-type: none"> • Create and manage survey forms • Configure and manage the server and users' permissions • Review survey results, reports, and respondents' audio responses
<p>Uptivity Database</p>	<p>Call information and respondent input and responses are recorded in this database as survey records. Reports are generated from these records.</p>

Requirements

PBX

TDM/ISDN-Supported PBXs

Uptivity Survey is supported with any PBX. Some PBXs may not support certain features. For related information, see [Uptivity Survey Call Linking](#).

Hardware, Software, and Licensing

Hardware and software requirements vary by PBX.

NICE Uptivity Survey

Uptivity Survey can be deployed with NICE Uptivity on the same server, on a separate server, or as a standalone product (that is, without call recording). You can find customer site requirements in the online help for NICE Uptivity (search keyword *site requirements*).

Hardware

Hardware specifications vary depending on system configuration and usage requirements. Hardware is specified by the NICE Uptivity Sales Engineering team during the sales process. Virtual servers are not supported.

The following third-party hardware is specifically required:

- AudioCodes Ai-Logix DT audio capture card. Either DT3209 (single-span) or DT6409 (dual-span) may be used.

Software and Licensing

The following required software is provided through the Uptivity Survey installation team:

- NICE Uptivity Survey (v5.6 or later)
- NICE Uptivity (v5.6 or later)

The following third-party software is also required:

- AudioCodes SmartWORKS v5.2 or higher.

Requirements

Uptivity Survey is a separately-licensed module of NICE Uptivity.

Performance Considerations

Performance Guidelines

The following are general performance guidelines for this product. For more information, see [Uptivity Survey Call Linking](#).

- Only one PBX can use the Uptivity Survey server.
- A dedicated Uptivity Survey server can safely handle 240 channels. The number of channels is limited by the number of voice boards supported by the server hardware.
- One survey channel should be considered the same as one concurrent recording when calculating server performance and capacity needs. The number of survey channels needed varies based on length of survey, acceptance rate, caller engagement, whether callers leave audio messages, etc.

Beep Tone

Uptivity Survey for TDM trunks plays a beep tone at the end of **Collect Customer Information** questions, before the caller starts speaking.

Uptivity Survey Call Linking

This feature allows you to link completed surveys to interactions recorded in NICE Uptivity. It is only supported in TDM environments where Avaya TSAPI has been configured to send UCID to NICE Uptivity for every call. The Uptivity Survey server and the recording server must be in the same time zone in order for call linking to work. If multiple locations or PBXs transfer calls to one Uptivity Survey server, call linking will not work if call recording is being done on two different NICE Uptivity servers and Uptivity Survey is running on only one of those servers.

Uptivity Survey call linking typically involves matching the ANI (CallerID) of the call recording with the ANI for the completed survey. In some telephony environments and configurations, the ANI in the call recording database table can be four digits, and the ANI in the surveys database table can be one of several different values.

For example, this behavior is known to occur with some Avaya configurations. Avaya Communication Manager’s Public Unknown Numbering setting can affect how the survey record ANI appears:

- If the setting is not configured, the ANI shows up as "anonymous" (see Figure 1).
- If the setting is configured without a CPN Prefix, the ANI in the recordings table shows as a four-digit extension number. This is the same way it appears in the recordings table (see Figure 2).
- If the setting is configured with a CPN Prefix, the ANI in the surveys table shows as the prefix plus the four-digit extension number.

Results		Messages								
	id	survey_id	survey_date	duration	dnis	ani	ip_address	recording_id	survey_source	
524	524	73	2013-12-18 12:43:11.000	12	4202	16145557009		6594	ivr	
525	525	74	2013-12-18 12:44:55.000	17	4202	16145557009		6596	ivr	
526	526	74	2013-12-18 12:45:27.000	16	4202	16145557009		6597	ivr	
527	527	74	2013-12-18 12:45:54.000	17	4202	16145557009		6598	ivr	
528	528	75	2014-01-07 11:07:22.670	4	4203	16145557009		6648	ivr	
529	529	75	2014-01-07 11:08:52.057	12	4203	16145557009		6650	ivr	
530	530	75	2014-02-10 08:57:43.697	16	4203	16145557011		NULL	ivr	
531	531	75	2014-02-10 08:59:54.277	51	4203	16145557011		NULL	ivr	
532	532	75	2014-02-10 09:03:49.143	14	4203	16145557011		NULL	ivr	
533	533	68	2014-03-07 16:09:51.490	29	4201	16145557011		8583	ivr	
534	534	68	2014-03-07 16:30:49.467	17	4201	16145557011		NULL	ivr	
535	535	68	2014-03-07 16:31:42.467	14	4201	16145557009		NULL	ivr	
536	536	68	2014-03-10 15:23:19.100	11	4201	16145557011		NULL	ivr	
537	537	68	2014-03-10 15:25:55.887	14	4201	16145557009		NULL	ivr	
538	538	68	2014-03-10 15:34:47.310	8	4201	anonymous		NULL	ivr	
539	539	68	2014-03-10 15:36:16.253	9	4201	anonymous		NULL	ivr	
540	540	68	2014-03-10 15:36:53.540	12	4201	anonymous		NULL	ivr	
541	541	68	2014-03-10 15:54:41.747	8	4201	7011		8604	ivr	
542	542	68	2014-03-10 15:57:09.557	8	4201	7011		8606	ivr	

Figure 1

Requirements

	ident	recording_time	device_id	filename	recording_type	ani	dnis	user
1...	8585	1394209800	7009	F:\CallCopy\Archive\20140307\7009\7009-16-30-00.csa	S	7009	7011	
1...	8586	1394209800	7011	F:\CallCopy\Archive\20140307\7011\7011-16-30-00.csa	S	7009	7011	
1...	8587	1394209842	7011	F:\CallCopy\Archive\20140307\7011\7011-16-30-42.csa	S	7009	7011	
1...	8588	1394209842	7009	F:\CallCopy\Archive\20140307\7009\7009-16-30-42.csa	S	7009	7011	
1...	8589	1394209895	7009	F:\CallCopy\Archive\20140307\7009\7009-16-31-35.csa	S	7011	7009	
1...	8590	1394209895	7011	F:\CallCopy\Archive\20140307\7011\7011-16-31-35.csa	S	7011	7009	
1...	8591	1394464909	7011	F:\CallCopy\Recordings\TSAPI\20140310\7011\7011-...	S	7009	7011	
1...	8592	1394464909	7009	F:\CallCopy\Recordings\TSAPI\20140310\7009\7009-...	S	7009	7011	
1...	8593	1394464981	7011	F:\CallCopy\Recordings\TSAPI\20140310\7011\7011-...	S	7009	7011	
1...	8594	1394464981	7009	F:\CallCopy\Recordings\TSAPI\20140310\7009\7009-...	S	7009	7011	
1...	8595	1394465150	7009	F:\CallCopy\Recordings\TSAPI\20140310\7009\7009-...	S	6145555003	7009	
1...	8596	1394465600	7009	F:\CallCopy\Recordings\TSAPI\20140310\7009\7009-...	S	6145555003	7009	
1...	8597	1394465650	7011	F:\CallCopy\Recordings\TSAPI\20140310\7011\7011-...	S	7009	7011	
1...	8598	1394465650	7009	F:\CallCopy\Recordings\TSAPI\20140310\7009\7009-...	S	7009	7011	
1...	8599	1394465678	7011	F:\CallCopy\Recordings\TSAPI\20140310\7011\7011-...	S	7009	7011	
1...	8600	1394465678	7009	F:\CallCopy\Recordings\TSAPI\20140310\7009\7009-...	S	7009	7011	
1...	8601	1394465773	7009	F:\CallCopy\Recordings\TSAPI\20140310\7009\7009-...	S	7011	7009	
1...	8602	1394465773	7011	F:\CallCopy\Recordings\TSAPI\20140310\7011\7011-...	S	7011	7009	
1...	8603	1394465807	7009	F:\CallCopy\Recordings\TSAPI\20140310\7009\7009-...	S	6145555003	7009	
1...	8604	1394466878	7011	F:\CallCopy\Recordings\TSAPI\20140310\7011\7011-...	S	7009	7011	
1...	8605	1394466878	7009	F:\CallCopy\Recordings\TSAPI\20140310\7009\7009-...	S	7009	7011	

Figure 2

Differences in ANI formatting can affect both standard call-survey linking and post-survey call-survey linking (see [Post-Survey Linker \(Optional\)](#)).

AudioCodes Configuration

Wiring Example

Uptivity Survey uses one or more Ai-Logix cards installed in the Uptivity Survey server to deliver surveys and record responses.

The customer is responsible for installing the card(s) in the server, and for performing any necessary cabling to connect the card(s) to the telephony network. The Uptivity Survey installation team will configure the card(s) using the AudioCodes SmartWORKS software.

A wiring diagram example is shown here. The T1 might need to be connected via a cross-over cable if connecting to a PBX or ACD. A T1 deployed with a PRI layer is preferred for speed of connectivity.

For more information, refer to AudioCodes documentation, available from the AudioCodes website or through Uptivity Support.

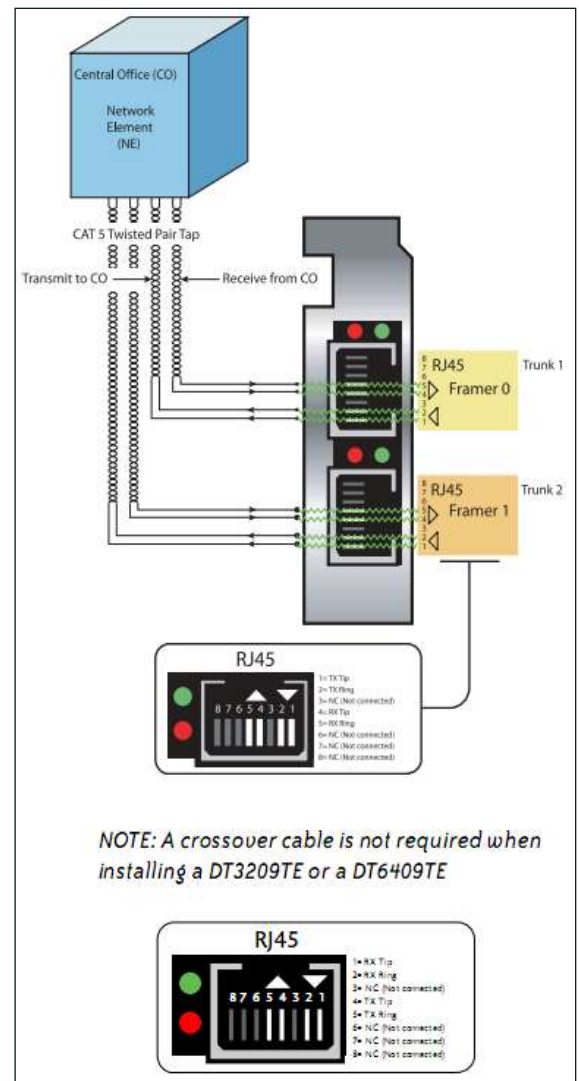

Configure the Ai-Logix Card

SmartWORKS software from AudioCodes is used to configure the Ai-Logix cards. This procedure is performed by the Uptivity Survey installation team and assumes SmartWORKS has already been installed on the Uptivity Survey server. The Ai-Logix card settings must match those on your PBX. For details, see [Appendix: PBX Configuration Examples](#).

To configure the Ai-Logix card(s) in SmartWORKS:

1. Open the SmartControl Panel Applet located in the Control Panel.
2. On the **Board** tab of the window, verify the desired board number is selected and confirm the TDM Encoding setting is μ -Law.
3. Click the **Digital Network** tab.
4. Under **Framing**, select **ESF** from the drop-down list.
5. Under **Line Coding**, select **B8ZS** from the drop-down list
6. Under **Signaling Protocol**, select **ISDN** from the drop-down list.
7. Under **Variant**, select **National 2** (NI2) from the drop-down list.

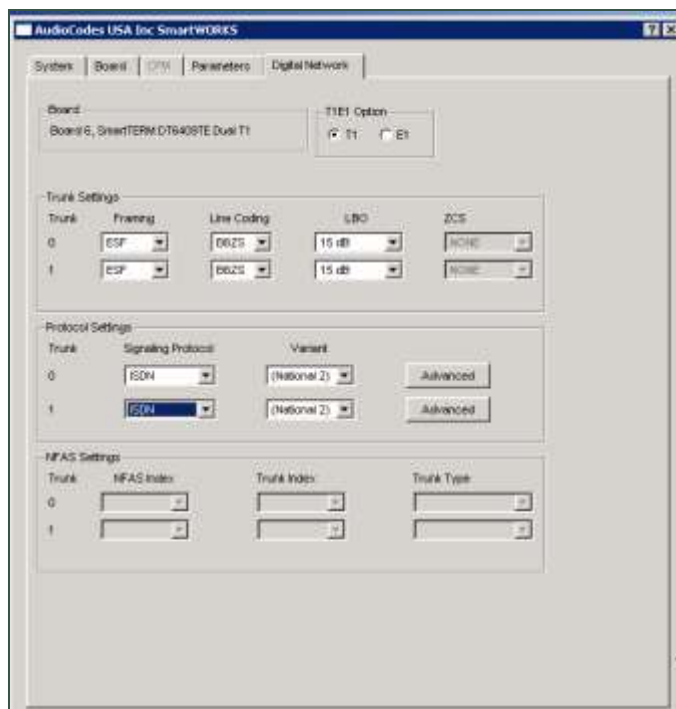

This image shows configuration of a dual-port card serving two T1s. Most Uptivity Survey systems will have only a single span (port) available.

Verify Ai-Logix Card Operation

The Uptivity Survey installation team can verify proper operation of the Ai-Logix card(s) using AudioCodes SmartView software, part of the SmartWORKS package, to view alarm states. These states let you verify that the T1 layer is configured and connected cleanly to the CPE.



To view alarms in SmartView:

8. On the Uptivity Survey server, shut down any NICE Uptivity applications.
9. From the Start menu, navigate to **Programs > AI-Logix > SmartWORKS** and launch **SmartView**.
10. Click **System** and select **MTGetFramerAlarmStatus**.

The following alarm screen is initiated. An alarm value greater than 0 (e.g. a value other than "--") on the Framer Status screen may indicate a wiring or configuration issue. Refer to AudioCodes documentation, available from the AudioCodes website or through Uptivity Support, for troubleshooting.

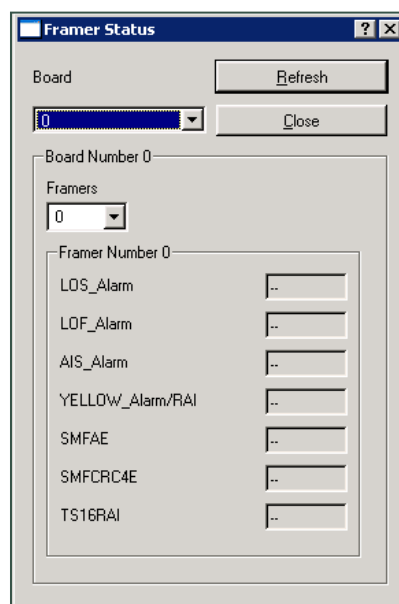

PBX Configuration

Tasks in this section are performed by the customer. See your PBX documentation for specific steps to perform the tasks mentioned in this section.

Configure DNIS and ANI

The following PBX configurations must be set:

- A unique DNIS for each survey
- Call routing to send both direct calls (that is, toll-free calls from customers) and forwarded calls to the Uptivity Survey engine.
- A dial plan to pass the DNIS and the ANI (that is, the originating caller or the transferring agent's PBX number, either agent ID or extension) to the Uptivity Survey engine.

Configure UCID for Uptivity Survey Call Linking

For survey call linking to work properly, the Avaya CM must be configured to send UCID to the Uptivity WFO recording core on every call.

To configure UCID:

1. Log in to the Avaya CM.
2. Run the following command: `change system-parameters features`.
3. Browse to **Create Universal Call ID (UCID)?** and set the parameter to **Y** (see Figure 1).
4. Browse to **Send UCID to ASAI?** and set the parameter to **Y**.
5. Save the changes.

```

change system-parameters features Page 5 of 19
FEATURE-RELATED SYSTEM PARAMETERS

SYSTEM PRINTER PARAMETERS
Endpoint: _____ Lines Per Page: 60

SYSTEM-WIDE PARAMETERS
Switch Name: CallCopy
Emergency Extension Forwarding (min): 10
Enable Inter-Gateway Alternate Routing? y IGAR Over IP Trunks: skip
Enable Dial Plan Transparency in Survivable Mode? n
COR to Use for DPT: station

MALIGNOUS CALL TRACE PARAMETERS
Apply MCT Warning Tone? n MCT Voice Recorder Trunk Group: ____
Delay Sending RElease (seconds): 0

SEND ALL CALLS OPTIONS
Send All Calls Applies to: station Auto Inspect on Send All Calls? n
Preserve previous AUX Work button states after deactivation? n

UNIVERSAL CALL ID
Create Universal Call ID (UCID)? y UCID Network Mode ID: 4

```

Figure 1

```

change system-parameters Features Page 13 of 19
FEATURE-RELATED SYSTEM PARAMETERS

CALL CENTER MISCELLANEOUS
Callr-info Display Tiner (sec): 10
Clear Callr-info: next-call
Allow Ringer-off with Auto-Answer? n

Reporting for PC Non-Predictive Calls? n

Agent/Caller Disconnect Tones? n
Interruptible Aux Notification Tiner (sec): 3
Zip Tone Burst for Callmaster Endpoints: double

ASAI
Copy ASAI UUI During Conference/Transfer? n
Call Classification After Answer Supervision? n
Send UCID to ASAI? y
For ASAI Send DTMF Tone to Call Originator? y

```

Figure 2

Install and Configure Uptivity Survey

This section explains the tasks for the Uptivity team installing Uptivity Survey. Uptivity Survey **must** be deployed on the server where the Ai-Logix card and AudioCodes SmartWORKS software were installed. This can be:

- On the same server as NICE Uptivity – Only the instructions in this section are needed
- On a separate server from NICE Uptivity –
 - Complete the instructions in this section
 - Install the NICE Uptivity **Logger** service (Logger.exe) and **CometDaemon**
 - On the server hosting the **Web Portal**, create a new server node and **CometDaemon** entry for the Uptivity Survey server
 - Add the Uptivity Survey server and both the **Logger** and **SurveyControllerIVR** services to the **Service Manager** in the **Web Portal**
- Without call recording – Complete the NICE Uptivity installation, skipping tasks for call recording

For related information, see the *NICE Uptivity Installation Guide* and online help.

Windows Server Tasks

Perform these tasks on the Windows server hosting Uptivity Survey.

Install the Uptivity Survey Server Software

Uptivity Survey is included with the base NICE Uptivity installation package, but requires proper licensing. Run the installation wizard and select **Base Installation**. For more information, see the appropriate *NICE Uptivity Installation Guide*.

Register Uptivity Survey as a Windows Service

The Uptivity Survey service is named cc_SurveyControllerIVR.exe. It should be registered as a service on the Windows server. Open a Command Prompt window on the server, change to the Recorder directory and run the following command:

```
Cc_SurveyControllerIVR.exe -install
```

If successful, a dialog box will appear and display the message “Service installed successfully.”

Configure the Settings.INI File

Uptivity Survey settings are stored in the settings.ini file used by NICE Uptivity. These settings must be configured for proper operation of the server. The file is located in the base folder where the NICE Uptivity software was installed.

Uptivity Survey settings and their default values (if applicable) are shown on the left in this table, with additional explanation of the settings detailed on the right.

[surveys]	
NumberOfAudiocodesChannels=	Number of voice board channels. This is a required setting.
MaximumDigitLengthForAPrompt=1	Maximum number of digits the survey will expect to collect, used when you want to be able to have answers that are more than one digit. This is an optional setting.
PutANIInDigitString=	Used when the PBX isn't sending an ANI*DNIS string, it is only sending a DNIS string. Possible values: Y or N. This is an optional setting.
Uptivity SurveyEngineType=CCSURVEYENGINE	All non-legacy Uptivity Survey servers should be CCSURVEYENGINE. Possible values: CCSURVEYENGINE or SOAP. This is an optional setting for current versions.
RepeatQuestionAfterInvalid=N	Set to Y if you want to repeat the question when an invalid digit is pressed. An Invalid_Response file must also be set up. Possible values: Y or N. This is an optional setting,
DigitTimeOut=3000	Specifies the length of time (in milliseconds) Uptivity Survey waits if the respondent has to enter digits. This is an optional setting.
SoapURL=	This setting has been deprecated; only required for legacy SOAP engine.
SoapWSDL=	This setting has been deprecated; only required for legacy SOAP engine.

Install and Configure Uptivity Survey

Add Uptivity Survey as an Allowed Application

The Windows Data Execution Prevention (DEP) setting helps protect against viruses and other security threats. The Uptivity Survey service (cc_SurveyControllerIVR.exe) must be added to the DEP setting in order to perform remote data execution.

If this procedure is not performed, the IVR will respond with an "Access Violation" message on the respondent's phone, and the violation will also be logged in the cc_SurveyIVR-*.log files where * is the channel number.

To add the Uptivity Survey Controller as an allowed application:

1. Navigate to Control Panel > System > Advanced > Performance – Settings > Data Execution Prevention.
2. Click **Add**.
3. Navigate to the folder where Uptivity Survey was installed and select cc_SurveyControllerIVR.exe. Click **Open**. If you are prompted to insert a disk, click **Cancel**.
4. Click **OK**.



Install Default Files

Default files are available from the Uptivity Survey installation team. Manually create the Prompts folder in the Recorder directory and copy the default files into it.

Web Portal Tasks

Add the Application to the Uptivity Service Manager

i NICE Uptivity normally requires that the application name be entered as an exact match for the corresponding EXE file. This service is an *exception* to that rule.

To add the service to the Service Manager:

1. Click **Administration** > **Tools** > **Service Manager**.
2. Expand the Server Node and click **Add Application**.
3. Under **Application**, enter the name of the service:
CallCopySurveyControllerService.
4. Select **Yes** from the drop-down list under **Auto-Restart** and then click **Save**.

Enable Uptivity Survey Score Column in Call Lists

This task can be performed as part of the Uptivity Survey installation or by each user according to their preferences.

1. Click **Recorded Interactions** > **Call List** (or **Interactions List** if you use the HTML5 playback).
2. Click **Settings** in the upper-right corner.
3. Under **Other Columns**, select the box for **Survey Score**.
4. Click **Save**.

Uptivity Survey Call Linking (Optional)

This feature does not work in all environments. For related information, see [Uptivity Survey Call Linking](#) and [Configure UCID for Uptivity Survey Call Linking](#). Installation engineers will need to obtain the correct script for the customer's environment from Uptivity Development prior to configuring this feature.

Install and Configure Uptivity Survey

Install the Uptivity Survey Linking TSAPI Script

1. Browse to the directory containing cc_SurveyControllerIVR.exe, typically C:\Program Files (x86)\CallCopy\Recorder.
2. Create a **Scripts** folder in that directory.
3. Copy the script provided by Development into the folder.

Configure the Settings.INI File for Uptivity Survey Linking

You must add entries to the settings.ini file to enable survey call linking. For more information on this file, see [Configure the Settings.INI File](#).

These settings let Uptivity Survey process the information provided by Avaya TSAPI and relate it to information from NICE Uptivity Call Recording. Therefore, the settings for the Avaya TSAPI section in this INI file must match the settings in the Avaya TSAPI CTI module of the NICE Uptivity CTI Core recording the calls used with Uptivity Survey.

Before modifying the INI file, you must obtain the trunk identifier used with Uptivity Survey by Avaya TSAPI. To do this, locate a transfer to Uptivity Survey in the Avaya TSAPI channel events log. You should see the trunk identifier (trunkGroup_#=) in the message. In the example shown below, the value is shown as "trunkGroup_0=5".

```
2012-06-05 07:35:05.990 Info 0
Channel 0[1155] Type: CTI_EVENT_AVAYA_TSAPI 8216(67) CSTA_TRANSFERRED
IP: 2012-
06-05 07:35:05.990 Info 0 Channel
0[1155]
Msg==>timeReceived=07:35:05.943|eventType=67|eventClass=4|monitorCrossR
efId=8|primaryOldCallID=14730|secondaryOldCallID=14705|transferringDevi
ce=8305|transferredDevice=8305|primaryOldDeviceID=8305|secondaryOldDevi
ceID=8305|numberOfTrunks=1|trunkInfoCallId_0=14705|trunkInfoDeviceId_0=
T14705#1|trunkGroup_0=5|trunkMember_0=17|oci_ucid=00000000000000000000|
oci_trunkGroup=|oci_trunkMember=|oci_calledDevice=|oci_callingDevice=|u
cid=00001147051338899665|attEventType=132<==
```

Install and Configure Uptivity Survey

Settings for survey call linking are shown on the left in this table, with additional explanation of the settings detailed on the right. If a setting has the same value for every customer, that value is shown on the left as a "default".

[settings]	
modules=AvayaTsapi	Specifies the module being added to the Settings.ini file.
[AvayaTsapi]	
Servername=	Refer to customer's TSAPI CTI module settings.
serverusername=	Refer to customer's TSAPI CTI module settings.
serverpassword=	Refer to customer's TSAPI CTI module settings.
tsversion=	Refer to customer's TSAPI CTI module settings.
privatedatatype=	Refer to customer's TSAPI CTI module settings.
vdns=	VDN(s) used to transfer calls to the IVR; if more than one, separate them with a comma.
groups=	Add any hunt groups in order to get agent logins; if more than one, separate them with a comma
[scripting]	
recordingmatchcolumn=user8	Specifies the column being used to store the UCID, which is required to link surveys. The default column for TSAPI is user8.
[surveys]	
Settings for the IVR. The channel settings alter what number the board is treated as. These parameters allow Uptivity Survey to match TSAPI info to the board and channel from IVR	
NumberOfAudiocodesChannels=	Customer should provide the number of audio channels they are using.
PutANIInDigitString=Y	Instructs Uptivity Survey to include the ANI in the digit string. Should be set to Y.
Channel0BoardTrunk= Channel1BoardTrunk=	Defined earlier in this section. Enter the corresponding value for each channel. If there are multiple trunks, you will need to find the identifier for that trunk and repeat this sequence for the channels that relate to that trunk.

Post- Survey Linker (Optional)

Post-Survey Linker (PSL) is an additional means of linking call records and surveys. Linking is done after the call is recorded and the survey is completed. It can be used if:

- Linking was not performed when the Uptivity Survey service was first used
- The Uptivity Survey service could not complete the linking because the process was interrupted while the survey was being done
- The call recording record was not written to the database when the survey was completed. Uptivity Survey has to link the agent to the survey as it always adds the agent to the survey record. If the recording is not yet written to the database, Uptivity Survey cannot link the records.

PSL will attempt to link all surveys in the database that have the required data values. The time for this initial processing depends on the number of surveys in the database. The performance impact is minimal and can be controlled by INI file settings. Once PSL has checked a survey, it will not check the survey again.

PSL should be used as a supplemental, not primary, means of linking. The Uptivity Survey service uses CTI data that assures most surveys/calls will be linked accurately. That CTI data is not available to the PSL service. The PSL service is also slower than the Uptivity Survey service. Actual performance is system dependent.

No conflicts will occur if both survey call linking and PSL are run on the same server. PSL does not try to link surveys that are already linked to a recording.

For PSL to work:

- Customers must understand the CTI data their ACD/PBX provides for the call and survey records. Not all CTI integrations provide the necessary data.
- The call recording script must be updated to remove all hyphens from the ANI values.

PSL does not have to run on the same server as the Uptivity Survey engine but should for ease of administration.

Configure the Post-Survey Linker INI File

PSL initialization settings are stored in the PostSurveyLinker.ini file. These settings **must** be configured for the proper operation of the service. The file is located in C:\Program Files (x86)\CallCopy\Recorder\PostSurveyLinker.

i If the PostSurveyLinker folder is not present after the installation wizard runs, you may need to obtain it from NICE Uptivity Support and copy it to the Recorder directory.

You must configure at least one linking method. You can use all methods, and you can use multiple instances of a method. PSL uses the first method that matches a survey/call record's data. Therefore, methods should be entered in the INI file from most preferred to least preferred.

These methods can be used:

- **SurveyStartTimeAndMatchColumnToSurveyANI** — Matches survey start time/call record end time and a configured match column from the Recordings table. It must match both settings to link. For example, if the survey starts five seconds after the call end and the threshold is set to 10, but the match column value doesn't produce a match, the survey and call are not linked. The opposite is also true: if the column matches but the time threshold is not valid, no linking occurs. The settings required for this method are:

- recordingTimeTolerance=10
- matchColumn=

The match column can be any column from the call recordings table. The suggested column is Device ID or ANI.

- **SurveyStartTimeAndAgentID** — Matches survey start time/call record end time and **AgentID**. The setting required for this method is:
 - recordingTimeTolerance=10

The suggested time tolerance is 10 seconds. PSL will search plus-or-minus by this value. For example, if the tolerance is set to 10 seconds, Linker will search for surveys to link that have start times within ten seconds before or ten seconds after the end of the call. The wider the range, the less accurate the results may be. Also, if the server running Uptivity Survey is not time-synched to the server running NICE Uptivity, or is in another time zone entirely, linking will be difficult if not impossible.

Install and Configure Uptivity Survey

Post-Survey Linker INI settings and their default values (if applicable) are shown on the left in this table, with additional explanation of the settings detailed on the right.

[postUptivity SurveyLinker]	
maxSurveysReturned=	Limits the number of records queried from the database. Looks for oldest records first and tracks the last record checked. This check persists through any shutdowns. Value is stored in a local file which can be deleted if you want to re-run PSL.
Period=	Frequency (in minutes) that PSL checks for survey records.
linkMethods=	Number of link method entries in the ini file. If this value is less than the number of configured methods, some methods will not be used. For example, if this value is two and three methods are configured, only the first two will be used.
[linkMethod_0] (additional, numbered linkMethod sections can be included, such as linkMethod_1, and so forth)	
type=	Possible value: one of the linking methods (SurveyStartTimeAndMatchColumnToUptivity SurveyANI or SurveyStartTimeAndAgentID).
recordingTimeTolerance=	Required for either linking method. Defines (in seconds) a length of time between the end of a recorded call and the start of a survey. See the introduction to this section for details.
matchColumn=	Required when type=SurveyStartTimeAndMatchColumnToSurveyANI. Defines a field in the recordings table to evaluate for possible matches between a recorded call and a survey. See the introduction to this section for details.

Register Post-Survey Linker as a Windows Service

Post-Survey Linker should be registered as a service on the Windows server:

Open a Command Prompt window, change to the CallCopy Recorder\PostUptivity SurveyLinker directory, and run the following command:

```
postSurveyLinker.exe -svcinst -autostart
```

If successful, the Command Prompt window will display the message "Service Installed."

Add the Application to the Service Manager

To add Post-Survey Linker to the Service Manager:

1. Click **Administration > Tools > Service Manager**.
2. Expand the Server Node and click **Add Application**.
3. Under **Application**, enter the name of the service: **postSurveyLinker.exe**.
4. Select **Yes** from the drop-down list under **Auto-Restart**.
5. Click **Save**.

Security

Permissions

You must be granted permissions to work with surveys. If you need to work with Uptivity Survey and are unable to do so, consult your application administrator.

i Group permissions are not enforced by Uptivity Survey. A user who has access to Uptivity Survey reports can see survey results for any agent.

The following components need Windows-level permissions:

- **IIS account running Web Portal** — Read/Write permissions to the Audio Prompt Upload Directory and the Audio Recording Directory. If Uptivity Survey is installed on a **separate server** from **Web Portal**, the IIS account must be a service account with explicit read/write access to the prompts and recordings directories on the Uptivity Survey server.
- **Uptivity Survey Module** — Read permission to the Audio Prompt Upload Directory. Write permission to the Audio Recording Directory.

Install and Configure Uptivity Survey

- **Reporting Server** — Read permission to the Audio Recording Directory if respondents are allowed to leave audio responses to questions.

The Uptivity Survey installation wizard establishes the needed permissions for the database and other NICE Uptivity modules if applicable.

Auditing

Uptivity Survey relies on NICE Uptivity's auditing function. No specific Uptivity Survey-related actions or data are tracked.

Encryption

The audio prompt and audio response recordings are not encrypted. Typically, surveys should not provide respondents with sensitive information or ask them to provide sensitive information.

Archiving

Audio files used and created by Uptivity Survey are not archived.

Uptivity Survey Administration



Manage DNIS Values

A DNIS is a unique identifier that the PBX sends to Uptivity Survey. The DNIS allows specific surveys to be associated with specific dialed numbers (DNIS). Using this methodology, one Uptivity Survey engine can support many unique surveys, each playing their own messages and asking for their own responses.

Configure DNIS Values

To add DNIS values:

1. Click **Administration > Add-Ons > Surveys > DNIS List**.
2. Click **Add**.
3. On the new line, enter values under **DNIS** and **Comment**. The comment should be a client name or some explanation of how the DNIS will be used in the survey work.
4. Click the Save  icon.

To edit or delete DNIS values, follow the same procedure but click the Edit  icon or the Delete  icon at step 3.

Import Multiple DNIS Values

Multiple DNIS values can be added at one time using a CSV file. For example, all the DNIS values used by your phones can be entered. This action avoids the repetitive work of entering values each time a DNIS is needed for a survey. Uptivity Surveys are not applied to calls received through a DNIS until that DNIS is assigned to a survey form.

Entries in the CSV file must fit this format: DNIS, Comment. Each entry should be on a separate line. A CSV file can be created in Microsoft Excel. Some telephony equipment will export DNIS data as a file.

To import a CSV file of DNIS values:

1. Click **Administration > Add-Ons > Surveys > DNIS List**.
2. Click **Import**.
3. Browse to the location of the CSV file, select it, and click **OK**.

Uptivity Survey Administration

4. If the first row in the CSV file is NOT a header (that is, it is a DNIS/Comment value), clear the **File contains a header row** check box.
5. Click **Upload File**. Review the records that are ready for importing.
6. If any of the records are not correct, click **Cancel**, then edit the file and repeat the import. Otherwise, go to step 7.
7. If the records are correct, click **Import**.

Specify Uptivity Survey Audio Directory Settings

Uptivity Survey requires these two directories, and the application must have Create/Write permission for both:

- **Audio Prompt Upload Directory:** This is the location where messages and prompts are stored.
- **Audio Recording Directory:** This is the location where customer feedback recordings are stored.

Files stored in these directories can be added during creation of a survey or copied manually if you have access to the server's drive array. The supported formats are:

- WAV container encoded in GSM, u-Law or PCM16
- VOX 8k/6k
- AU container encoded in u-Law
- CSA mono/stereo

During upload to the site, files are converted as follows:

Uptivity Survey Type: T1-Based	
Bit rate	128kbps
Audio sample size	16-bit (linear)
Channels	1 (mono)
Audio sample rate	8kHz (G.711)
Audio format	PCM

To specify these directories:

1. Create the directories in the file system (for example, C:\Uptivity SurveyPrompts). Uptivity Survey does not require specific names for these directories.
2. Click **Administration > Add-Ons > Surveys > Survey Settings**.
3. Enter full path names for both directories.
4. Set the **Survey Audio Format** to T1.
5. Click **Save**.

Survey Forms Listing

	Name	Status	DMS	Attempted Count	Created By	Created On	Last Modified By	Last Modified On
Edit	FridaySurvey	<input checked="" type="checkbox"/> Active		0	Administrator Administrator	10/5/2012 10:51:18 AM	Administrator Administrator	10/5/2012 10:59:51 AM
Edit	surveyFor5090	<input type="checkbox"/> Disabled		500	Administrator Administrator	5/9/2012 4:58:28 PM	Administrator Administrator	2/15/2013 5:18:07 PM
Edit	SurveyFormToDelete	<input checked="" type="checkbox"/> Active	1005,0000	0	Administrator Administrator	9/5/2013 1:28:06 PM	Administrator Administrator	9/5/2013 1:28:48 PM
Edit	SurveyFormToEdit	<input checked="" type="checkbox"/> Active	1004	0	Administrator Administrator	9/5/2013 1:18:44 PM	Administrator Administrator	9/5/2013 1:24:19 PM
Edit	SurveyFormToday	<input checked="" type="checkbox"/> In Progress		0	Administrator Administrator	9/18/2012 12:15:50 PM	Administrator Administrator	9/18/2012 12:17:23 PM
Edit	testAudioForm(sjkt.lj)	<input checked="" type="checkbox"/> Active	1003	0	Administrator Administrator	2/15/2013 3:18:58 PM	Administrator Administrator	2/15/2013 5:18:28 PM

The **Survey Forms Listing** screen displays when you click **Surveys > Manage Surveys**. It provides a list of surveys in your system, as shown above, and enables you to do the following tasks.

- The default view shows all active surveys in the system. You can alter this view by using the **Filter by Status** drop-down. The choices available are **All**, **Active**, **Disabled**, and **In Progress**.
- Clicking the **Edit** button to the left of the survey name will launch the **Survey Editor**. For details, see [Create Survey](#).
- To quickly change the status of a survey from **Disabled** to **Active** (or vice versa), select/clear the check box in the **Status** column. Uptivity Survey status can also be changed in the **Survey Editor**.
- The **Attempted Count** value indicates the number of respondents who have started the survey form.
- The **Import** button can be used to load XML files and use them as survey forms. The files must be formatted exactly as those created using the **Survey Editor**. Custom forms are not supported.

Create Survey

i Uptivity Survey auto-saves forms while you are working on them. The **Save Draft** and **Save** options identify any missing required field data.

inContact recommends creating survey questions, responses, and actions on paper before trying to create the survey in Uptivity Survey. Each survey you create should have a unique, descriptive name. inContact recommends that the name also incorporate a version number.

Uptivity Survey content is organized by section, question, and response. A survey must have at least one section, and all questions can be placed in that section. Using multiple sections can help you organize longer surveys. This image shows the section, question, and response portion of the **Survey Editor**.

The screenshot shows the 'Survey Form' editor. At the top, there's a 'Section Title' field with 'Test Section 1' entered. Below it, a 'Question #1' section contains a large text input area. Underneath the input area are several controls: 'Default Next Question' (a dropdown menu), 'Question Type' (set to 'Present Question and Wait for Result'), 'Audio File' (with an 'Upload Audio File' button), 'Response Type' (set to 'Horizontal Radio Buttons'), and 'Possible Points' (set to 0). At the bottom, there are checkboxes for 'Mark Survey Complete' (unchecked) and 'Show in Reporting' (checked).

You can use the  buttons to reorder or delete sections and questions.

You may need to allow for these special circumstances:



- **Invalid Responses** — You can record a WAV file called Invalid_Response and place it in the Prompts folder in the same directory as the Uptivity Survey executable. When Uptivity Surveys is configured with the **Repeat Question After Invalid** setting as **Yes**, this file will play and the question will repeat whenever the caller enters a digit that is not in your list of valid responses. For related information, see [Configure the Settings.INI File](#).

Question Repeats — Sometimes callers may want to have a question repeated. You can accomplish this by instructing them to enter a digit that is not on your list of valid responses, which will force them into the Invalid Response protocol. Be sure that your recorded Invalid_Response message takes both scenarios into account so that callers are not confused.

To build your survey in Uptivity Survey:

1. Click **Surveys > Create Survey**.
2. Enter a **Survey Name**.
3. **Optional:** Enter a **Description**.
4. Enter the **Min Percentage Threshold** and **Max Percentage Threshold**. Any survey whose score is below the minimum percentage is defined as "Negative." Any survey whose score is above the maximum percentage is defined as "Positive." Any score between the minimum and maximum thresholds is reported as "Neutral." These values appear on the Survey Summary and Survey Overview reports.
5. For **Recording Format**, select **GSM** from the drop-down list. This specifies the format of files produced when the customer records a verbal answer. GSM (a highly-compressed WAV format) is the only supported format is GSM.

i For more information on where these recordings are stored, see [Specify Uptivity Survey Audio Directory Settings](#). A new folder is automatically created for each survey and numbered according to the number of survey forms created (that is, the tenth survey is placed in a folder numbered "10").

6. In the **Available DNIS** field, select the number(s) from which calls will be directed to this survey. Click the right-facing arrow  to move the number to the **Attached DNIS** field or the left-facing arrow  to remove numbers from the **Attached DNIS** field.
7. Click **Add New Section**.
8. Enter a **Section Title**.
9. Click **Add New Question**.
10. Enter the text of the question in the text box. Your entry should be the text within the question's recorded audio file for consistency and future troubleshooting.

Uptivity Survey Administration

11. **Optional:** Select a value from the **Default Next Question** drop-down list to specify the next question that will be presented in the survey.
12. Select a **Question Type**. For additional information about question types and corresponding response options, see [Question Types](#).
13. Click **Upload Audio File** and navigate to the file with the question. This is the location of the recording audio file that will be stored in the Audio Prompt Upload Directory.
14. **Response Type** is not used by audio-based surveys.
15. **Optional:** Select the **Mark Survey Complete** checkbox.

Example: You have a five question survey, but the fifth question is optional. You should select this checkbox for the fourth question. Otherwise, if the customer hangs up after Question 4, Question 5 would be scored as 0 out of the possible points. In addition, any survey not reaching Question 4 would be marked as "incomplete" and reporting results will not be accurate.

16. **Optional:** Clear the **Show in Reporting** checkbox if you do not want this question included within the reporting values. Since the system considers greetings, closings, or transitions without responses to be "questions", you may want to clear this checkbox for these items. Otherwise, this question will display with no data responses.

i Possible Points is auto-calculated where applicable based on the list of responses.

17. Complete work on the survey by doing one of the following:
 - a. Click **Export** to export the survey form as an XML file.
 - b. Click **Delete** to remove in-progress forms while you're working on them. Do **not** delete forms that have been used; instead, disable them. For related information, see [Survey Forms Listing](#).
 - c. Click **Save Draft** to save your form and list it as **In Progress** in the **Survey Forms Listing**.
 - d. Click **Save** to save and close the form, after which it will appear in the **Survey Forms Listing**.

Question Types

Question Type	Used To:	Response Values
Present Question and Wait for Result	<ol style="list-style-type: none"> 1. Convey greeting, closing, instructions, or other information, and automatically advance after a wait period (defined at the time of installation in the settings.ini file) 2. Present a question and wait for touch-tone input 	<p>Response Text: Enter the text of the response</p> <p>Point Value: (optional)</p> <p>DTMF: touch-tone input value for response (for example, 1 for Yes, 2 for No, and so on); each response must have a unique DTMF value</p> <p>Next Question: Allows you to direct the survey based on response (for example, Yes leads to Question 3, No to Question 4)</p>
Collect Customer Information	<p>Allow the customer to leave detailed feedback in the form of a recording. Recording length is bound only by available disk space. Recording continues until customer disconnects or presses "#" as instructed in your question audio file. Voice recordings are playable from within reports, can be accessed from the Audio Recording Directory, or both. For related information, see Beep Tone.</p>	
Collect Digits	<p>Allow the customer to leave a string of numeric values (such as transaction number or customer ID) using a touch-tone keypad. Uptivity Survey advances when the caller presses "#" as instructed in your question audio file, or after the wait period (defined at time of installation in the settings.ini file)</p>	
End Survey	<p>Convey closing message. Call automatically disconnects after execution of this audio file.</p>	

Uptivity Survey Administration

<p>Threshold Branch</p>	<p>Direct respondents to specific questions based on cumulative score of earlier responses.</p> <p>Requires no audio file.</p> <p>Transparent to caller.</p> <p>Typically not appropriate for the Mark Survey Complete option.</p> <p>An example of this type of question and the associated logic is shown in the next section.</p>	<p>Negative Percentage Threshold: Surveys with current percentage below this value are negative (current accumulated points/current total possible points)</p> <p>Positive Percentage Threshold: surveys with current percentage above this value are positive (current accumulated points/current total possible points)</p> <p>Negative Next Question: Next question for surveys at negative threshold</p> <p>Neutral Next Question: Next question for surveys between thresholds</p> <p>Positive Next Question: Next question for surveys at positive threshold</p>
-------------------------	---	---

Threshold Branch Example

In this example, the survey is designed so that, if the technician's technical skills were not satisfactory, the caller is asked to leave verbal feedback and the survey ends immediately thereafter (see Figure 1). If the technician's technical skills were satisfactory, the caller is presented with another question prior to the survey's conclusion (see Figure 2).

Technical Skills		Score: 0 of 5 (0%)
Were you comfortable with your technician's knowledge of the application? Press 1 for yes. Press 2 for no.		
Digits Collected: 2		
Yes	<input type="checkbox"/>	0pts
No	<input checked="" type="checkbox"/>	
Allow verbal feedback if dissatisfied with technical knowledge.		
Digits Collected: 2		
<input type="checkbox"/>		
We're sorry that your experience with our technical support was less than satisfactory. At the tone, please record a detailed voice message regarding how we could have done better. Press the pound or number sign to stop recording.		
<input type="checkbox"/>		
<input type="checkbox"/>		
1-110934.wav		
Was your issue resolved within a satisfactory period of time? Press 1 for yes. Press 2 for no.		
Yes	<input type="checkbox"/>	
No	<input type="checkbox"/>	

Negative answer; caller asked to leave verbal comments. Final question is not presented.

Figure 1

Technical Skills		Score: 10 of 10 (100%)
Were you comfortable with your technician's knowledge of the application? Press 1 for yes. Press 2 for no.		
Digits Collected: 1		
Yes	<input checked="" type="checkbox"/>	5pts
No	<input type="checkbox"/>	
Allow verbal feedback if dissatisfied with technical knowledge.		
Digits Collected: 1		
<input type="checkbox"/>		
We're sorry that your experience with our technical support was less than satisfactory. At the tone, please record a detailed voice message regarding how we could have done better. Press the pound or number sign to stop recording.		
<input type="checkbox"/>		
<input type="checkbox"/>		
Was your issue resolved within a satisfactory period of time? Press 1 for yes. Press 2 for no.		
Digits Collected: 1		
Yes	<input checked="" type="checkbox"/>	5pts
No	<input type="checkbox"/>	
Conclusion		Score: 0 of 0 (N/A)
Thank you for participating in our Post-Support Survey. We appreciate your feedback.		
<input type="checkbox"/>		

Positive Answer leads to presentation of additional question

Figure 2

Search Attempted Surveys (Form Search)

Search Attempted Surveys

Survey: All
Record ID:
IP Address:

Start Date: 11/25/2013
DNIS:
Agent Name:

End Date: 11/25/2013
ANI:

No Surveys Found Matching Criteria

Pages: 1 of 1

If you have permission to view surveys, you will also be able to search for surveys which have been offered and wholly or partially completed. You can refine your search based on one or more of the following:

- **Survey** — Name of the survey.
- **Start Date** — Click the calendar icon to set a start date for a search period.
- **End Date** — Click the calendar icon to set an end date for a search period.
- **Record ID** — Each attempted survey is assigned a unique identification number by the system. If you know this number, you can search for a specific survey by entering that ID number here.
- **DNIS** — Enter the number(s) attached to the survey.
- **ANI** — To limit your search to surveys delivered to a specific caller, enter the ANI (CallerID) information here. Availability of ANI information is dependent on your telephony system. If the caller is manually transferred to the survey by an agent, the ANI may not reflect the original CallerID.
- **IP Address** — This field is not used.
- **Agent Name** — To limit your search to surveys associated with a specific agent, enter the agent's name here.

To search for surveys:

1. Click **Surveys > Form Search**.
2. Enter search criteria.
3. Click **Search**.

Uptivity Survey Reports

Uptivity Survey includes a number of pre-built reports, called Printable Reports. You can also use ad hoc reporting functionality to build reports using survey data. You must have appropriate permissions for reporting. For more information on permissions, talk to your NICE Uptivity application administrator or search online help for keyword *permissions*.

Reporting functionality, including how to generate printable reports and create ad hoc reports, is covered in online help for NICE Uptivity (select **Reporting** from the top-level menu). This section provides a reference to the reports specific to Uptivity Survey.



The screenshot shows the 'Survey Reporting' interface. On the left is a sidebar with 'Printable Reports' and sub-items: Analytics Reporting, Call Reporting, QA Reporting, System Reporting, and Survey Reporting. The main area has a 'Filter:' field and a 'Search' button. Below is a table of reports:

Report	Description	Date Created
Survey Detail	Detailed breakdown of survey responses	10/22/2013
Survey Detail Summary	Dated Summary of Survey Activity	10/22/2013
Survey Overview	Summary of all survey activity during a date range	10/22/2013
Survey Summary	Summary of Survey Activity	10/22/2013
Survey Summary by Agent	Survey Summary By Agent	10/22/2013
Survey Summary by Question	Provides a count of each given response to each of the questions in a survey form.	10/22/2013
Survey Summary by Response	Provides a count of each given response to each of the questions in a survey form given that one question has been provided with a particular response. This allows you to see how different segments of the surveyed population have answered questions.	10/22/2013

At the bottom right of the table area, it says 'Go To Page: 1 of 1'.

The **Survey Reporting** screen lists the available Printable Reports. The **Date Created** column shows the date that the template for the report type was created in the system.

Survey Detail Report

The **Survey Detail** report shows complete responses for one or more survey respondent(s) and also provides information about the respondent, such as DNIS and ANI.

i IP Address is not used at this time.

Form: CallCopy Customer Survey		Record: 53190
DNIS: 7533	ANI: 5010	Survey Date: 4/1/2011 9:38 AM
Survey Complete:	Yes	IP Address:
Satisfaction		Score: 10 of 10 (100%)
On a scale of one to five, five being the highest, how satisfied are you with the CallCopy software solution overall?		
Digits Collected: 5		
5	<input checked="" type="checkbox"/>	5pts
4	<input type="checkbox"/>	
3	<input type="checkbox"/>	
2	<input type="checkbox"/>	
1	<input type="checkbox"/>	

If respondents left a voice message for a question, a link to the message file appears in the report.

Close	Score: 0 of 0 (N/A)
Finally, one last question. If you could have one product enhancement, what would it be?	
	<input type="checkbox"/>
2-101411.wav	

Survey Detail Summary Report

The **Survey Detail Summary** lists all survey responses that match the search criteria. Click a survey to open the **Survey Detail** report for that survey. The **Recordings** column shows the number, if any, of respondent voice recordings.

 Survey Detail Summary For period beginning Tuesday, May 08, 2012 and ending Friday, June 08, 2012							
Selected Surveys: surveyFor5090							
Survey Complete: Complete							
Name	Date	DNIS	ANI	Score	RecordID	Recordings	Agent Name
surveyFor5090	5/9/2012	1001	1234	46.67%	5	0	agent9_first58 agent9_last58
surveyFor5090	5/9/2012	1001	1234	46.67%	6	0	Clifton Guiran
surveyFor5090	5/9/2012	1001	1234	60.00%	7	0	agent10_first58 agent10_last58
surveyFor5090	5/9/2012	1001	1234	53.33%	8	0	Alan Crow
surveyFor5090	5/9/2012	1001	1234	80.00%	9	0	Myron Galliano
surveyFor5090	5/9/2012	1001	1234	0.00%	10	0	Connie Francis
surveyFor5090	5/9/2012	1001	1234	40.00%	11	0	Connie Francis
surveyFor5090	5/9/2012	1001	1234	60.00%	12	0	agent10_first58 agent10_last58

Survey Overview Report

The **Survey Overview** report calculates the shown categories for each survey form in a time period. Positive, negative, and neutral ranges are defined on the Uptivity Survey form. If a survey form does not have any responses, it does not appear on the report.

 Survey Overview For period beginning Thursday, January 27, 2011 and ending Tuesday, September 27, 2011						
Name	Count	Complete	Incomplete	Positive	Negative	Neutral
CallCopy Customer Survey	12	11 (91.7%)	1 (8.3%)	4 (33.3%)	2 (16.7%)	4 (33.3%)

Survey Overview - 9/27/2011 CallCopy Recorder Reporting Service Page 1 of 1

Survey Summary Report

The **Survey Summary** report calculates the shown categories for all surveys in a time period, and displays them on a per-survey basis. If a survey form does not have any responses, it does not appear on the report.

- **Score** — Total score of survey responses and maximum possible score of a survey. The maximum possible score on a survey can vary based on the questions that a respondent is asked to answer. For example, one respondent may be asked to answer five questions with a total of 50 points. Another respondent, based on their answers, will be directed through seven questions with a total of 70 points. This fact must be considered when designing surveys.
- **Average Percentage (%)** — (Sum of each response's score)/(Sum of the possible score for each form)/Number of responses

 Survey Summary For period beginning Thursday, January 27, 2011 and ending Tuesday, September 27, 2011								
Name	Count	Complete	Incomplete	Positive	Negative	Neutral	Score	Avg %
CallCopy Customer Survey	12	11 (91.7%)	1 (8.3%)	4 (33.3%)	2 (16.7%)	4 (33.3%)	76 of 90	80.8%

Survey Summary - 9/27/2011 CallCopy Recorder Reporting Service Page 1 of 1

Survey Summary by Agent Report

Survey Summary by Agent allows you to select a set of agents over a specific date range, and displays the number of surveys completed for each agent, given survey score, total possible points, percentage overall score, and totals for each column.

The **Report Type** option determines how results are broken down and displayed:

- **Agent** — Total scores for all forms by agent as shown below
- **Form** — Scores by form and total scores for all forms for each agent
- **Section** — Scores for each section on the form
- **Question** — Scores for each question in each section on each form



Survey Summary by Question Report

The **Survey Summary by Question** report provides a count of each given response to each of the questions in a survey form. You can select a date range, the survey form to evaluate, DNIS/ANI numbers, and survey completion status. For each form evaluated, the generated report displays the number of surveys completed and average score, followed by counts and score percentages for each question in the form. The **Survey** field is required.

Start Date: 1/1/2009
End Date: 8/8/2012
Survey: surveyFor5090

DNIS:
ANI:
Survey Complete: Complete

1 of 1
Find | Next

Survey Summary by Question

For period beginning Thursday, January 01, 2009 and ending Wednesday, August 08, 2012

Selected Form: surveyFor5090

Survey	Number of Surveys	Average Score
surveyFor5090	0	0 of 0 (N/A)

Question	Response	Count	Percentage
Q1 On a scale of 1 to 5 - 5 is the best			
1		0	0.0%
2		0	0.0%
3		0	0.0%
4		0	0.0%
5		0	0.0%
Q2 On a scale of 1 to 5 - 5 is the best			
1		0	0.0%
2		0	0.0%
3		0	0.0%
4		0	0.0%
5		0	0.0%
Q3 On a scale of 1 to 5 - 5 is the best			
1		0	0.0%
2		0	0.0%
3		0	0.0%
4		0	0.0%
5		0	0.0%
Thank you for your time			

Survey Summary by Question - 8/8/2012
CallCopy Recorder Reporting Service
Page 1 of 1

Survey Summary by Response

Survey Summary by Response helps you identify the relationship between a response to one question and the responses to other questions. This allows you to see how different segments of the surveyed population have answered questions. This report works well with surveys where one question addresses a respondent's overall opinion of a product or service, and follow-up questions elicit the reasons or factors for that overall opinion.

For example, a car satisfaction survey may be designed where customers who purchased any new car within the last year are surveyed. One question asks them to rate their overall satisfaction with their car on a scale of 1 to 5, with 5 being the highest satisfaction. Additional questions ask how many times they have taken the car for repairs, the price of the car, the size of the car, the car's miles-per-gallon rate, and whether the car was the customer's first choice. Assume that these are the results:

Report 1: Question 1: Satisfaction rating: 1

- Question 2 -- Number of times cars repaired: 1
- Question 3 – Was this car your first choice?: No

Report 1: Question 1: Satisfaction rating: 5

- Question 2 -- Number of times cars repaired: 1
- Question 3 – Was this car your first choice?: Yes

In both cases, the car had to be repaired. However, the results suggest that satisfaction with the purchase was influenced by whether or not the customer was able to purchase their first choice. A customer may have wanted a \$35,000 car but had to settle for a \$20,000 car, which affected the satisfaction rating.

Multiple versions of this report may need to be created in order to identify the relationships between a question's responses and the responses on the other questions. In other words, if Question 1 has four possible responses, and that question is used as the overall or control question, then a report should be run for each response.

Uptivity Survey Reports

Survey, **Question ID**, and **Response** are required fields. The result fields are:

- **Count** —Number of respondents who selected a response
- **Score** —Actual total points for a response. If a response was worth two points and three respondents selected it, the **Score** value would be **6**.
- **Possible Score** — Number of response options multiplied by the point value for a response
- **Percentage** — $\text{Score} / \text{Possible Score}$

This report can be run for all questions except *Collect Customer Information* questions. Because this question type allows customers to leave a recorded voice message as a response, Uptivity Survey cannot include the response in any type of calculation. If you inadvertently include a question of this type as you build this report, Uptivity Survey will not populate the **Response** field and attempting to run the report generates the error message, "Response value must be selected."

If no respondents selected a response to a question, the response option does not appear on the report. For example, if no respondents selected response 2 for a question, the report shows numbers for responses 1, 3, 4, and 5.



Survey Summary by Response

For period beginning Tuesday, May 08, 2012 and ending Friday, June 08, 2012

This report summarizes the responses made by people who answered the question 'Q1 On a scale of 1 to 5 - 5 is the best' with the response: '1'.

Survey Complete: Yes

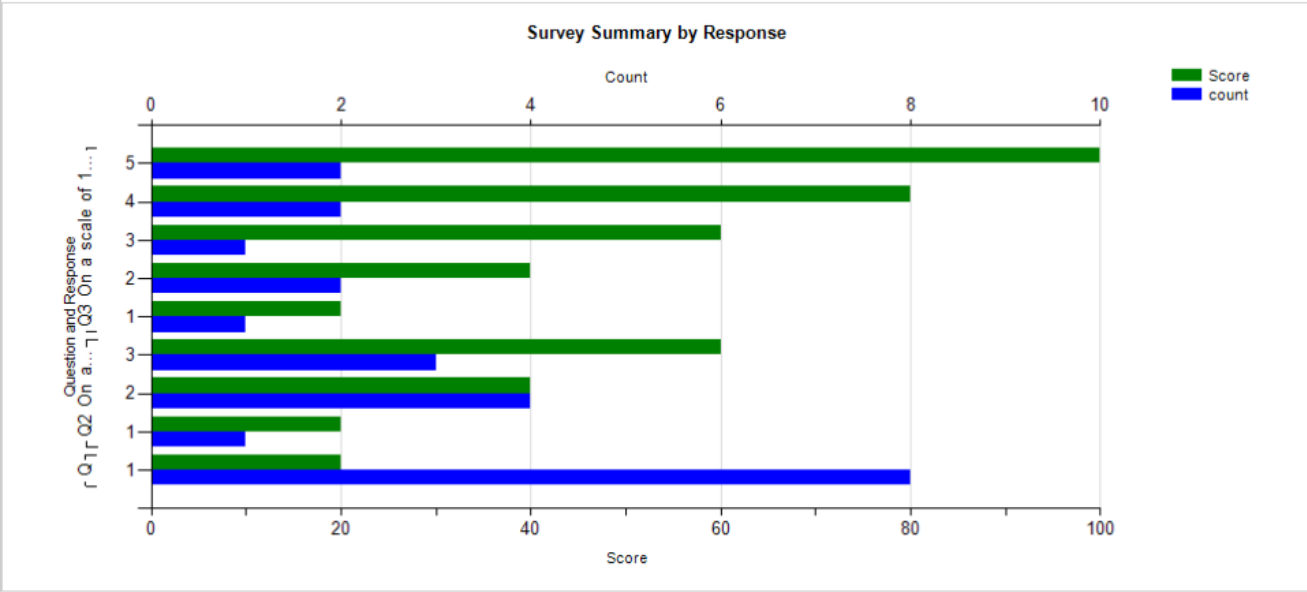

Survey:	surveyFor5090				
Question	Response	Count	Score	Possible Score	Percentage
Q1 On a scale of 1 to 5 - 5 is the best					
1		8	8	40	20.00%
		8	8	40	20.00%
Q2 On a scale of 1 to 5 - 5 is the best					
1		1	1	5	20.00%
2		4	8	20	40.00%
3		3	9	15	60.00%
		8	18	40	45.00%
Q3 On a scale of 1 to 5 - 5 is the best					
1		1	1	5	20.00%

Appendix: PBX Configuration Examples

This section provides screen images of PBX configuration examples for T1s and trunk groups used with Uptivity Survey. This is **not** an all-inclusive list and inContact makes no guarantees that these configurations will work in your scenario. You should always use documentation from your PBX manufacturer to configure PBX settings. Consult your PBX support or vendor for specific questions regarding your installation.

Avaya

DS1 Circuit Pack

```
CC Avaya: display dsl 01v3 (page 1) 10/27/2008 5:29:20 PM
                                DS1 CIRCUIT PACK
                                Location: 001V3
                                Bit Rate: 1.544
                                Line Compensation: 1
                                Signaling Mode: isdn-pri
                                Connect: pbx
                                TN-C7 Long Timers? n
                                Interworking Message: PROGress
                                Interface Companding: mulaw
                                Idle Code: 11111111
                                Name: * Survey Trunk
                                Line Coding: b8zs
                                Framing Mode: esf
                                Interface: network
                                Country Protocol: 1
                                Protocol Version: b
                                CRC? n
                                DCP/Analog Bearer Capability: 3.1kHz
                                T303 Timer(sec): 4
                                Slip Detection? y
                                Near-end CSU Type: other
                                Echo Cancellation? y
                                EC Direction: inward
                                EC Configuration: 4
                                Block Progress Indicator? n
```

Appendix: PBX Configuration Examples

```
CC Avaya: display ds1 01v3 (page 2) 10/27/2008 5:29:20 PM

                                DS1 CIRCUIT PACK

ESF DATA LINK OPTIONS

                                Network Management Protocol: tabs
Send ANSI-T1.403 One-Second Performance Reports? n
                                Far-end CSU Address: b
```

Trunk Group Configuration

```
CC Avaya: display trunk-group 10 (page 1) 10/27/2008 5:28:47 PM

                                TRUNK GROUP

Group Number: 10                                Group Type: isdn                                CDR Reports: y
Group Name: *Nortel                                COR: 1                                TN: 1                                TAC: *111
Direction: two-way                                Outgoing Display? y                                Carrier Medium: PRI/BRI
Dial Access? y                                Busy Threshold: 255                                Night Service:
Queue Length: 0
Service Type: tie                                Auth Code? n                                TestCall ITC: rest
TestCall BCC: 4                                Far End Test Line No:
```

Appendix: PBX Configuration Examples

```
CC Avaya: display trunk-group 10 (page 3) 10/27/2008 5:28:47 PM

TRUNK FEATURES
  ACA Assignment? n                Measured: none                Wideband Support? n
                                     Internal Alert? n                Maintenance Tests? y
                                     Data Restriction? n            NCA-TSC Trunk Member:
                                     Send Name: y                    Send Calling Number: y
                                     Used for DCS? n                    Send EMU Visitor CPN? n
  Suppress # Outpulsing? n        Format: public
  Outgoing Channel ID Encoding: preferred  UII IE Treatment: service-provider

                                     Replace Restricted Numbers? n
                                     Replace Unavailable Numbers? n
                                     Send Connected Number: y
  Network Call Redirection: none        Hold/Unhold Notifications? n
                                     Modify Tandem Calling Number? n
  Send UII IE? y
  Send UCID? y
  Send Codeset 6/7 LAI IE? y        Dsl Echo Cancellation? n

                                     US NI Delayed Calling Name Update? n
                                     Network (Japan) Needs Connect Before Disconnect? n
                                     Apply Local Ringback? n
```

```
CC Avaya: display trunk-group 10 (page 2) 10/27/2008 5:28:47 PM

  Group Type: isdn

TRUNK PARAMETERS
  Codeset to Send Display: 6          Codeset to Send National IEs: 6
  Max Message Size to Send: 260      Charge Advice: none
  Supplementary Service Protocol: a    Digit Handling (in/out): enbloc/enbloc

  Trunk Hunt: cyclical

  Incoming Calling Number - Delete:      Insert:          Digital Loss Group: 13
  Bit Rate: 1200                      Synchronization: async      Format:
  Disconnect Supervision - In? y Out? n      Duplex: full
  Answer Supervision Timeout: 0
```

eOn eQueue

T1 Line Assignment

```

Oct 29 08:12:24 ONLN      eOn eQueue      Rev:7.00.00-b01  equeue-a
Find  Add Change Delete      Print Quit
Line Assignment Modification
Number [E1750101]  Port [01.15.01 ]  Name [PRI TEST 1.15.1 ]
Line Info 1 [      ]  2 [      ]  3 [      ]
Type [TRUNK]  COS [1 ]  Group [1 ]  CallZone [ ]
Port Class [4 ]  T1 Class [5 ]  Password [ ]  VAN Grp [ ]
Lamp [0 ]  Aux Lamp [0 ]  Lamp Type [0 ]  Msg Lamp [0 ]
Port Comm. [ ]  IP [0 ]

Skill Set for Routing [ ]
Hotline/Direct In Number [D801 ]
Ring no Answer default [ ]

----- FORWARDS -----
Busy [ ]  Active [N ]  Internal ? [N ]
RNA [ ]  Active [N ]  Delay [ ]
All Calls [ ]  Active [N ]
Forward Setup Allowed  Internal [N ]  External [N ]

Find an assignment  F1 = HELP

```

T1 Class

```

Oct 29 07:14:23 ONLN      eOn eQueue      Rev:7.00.00-b01  equeue-a
Find Next Back Add Change Delete      Print Quit
T1 Class Modification

T1 Index [ 5 ]
Name [ISDN W/D NETWORK ]

Protocol (ESF/D4/TR8) [ESF ]
Zero Suppression (AMI/B8Z) [B8ZS ]
Default CSU (P/S) [P ]
ISDN Signaling (Y/N) [Y ]
Clear D-Channel (Y/N) [Y ]
Maintenance Channel Format (0/1) [0 ]
Network or User (N/U) [N ]
Line Build Out [0 ]

Find an assignment  F1 = HELP

```

Appendix: PBX Configuration Examples

Port Class

```
Oct 29 08:12:39 ONLN      eOn eQueue      Rev:7.00.00-b01  equeue-a
Find Next Back Add Change Delete      Print Quit
Port Class Modification

Port Class No. [ 4] Name [ISDN B CHANNEL ] Type [ 14]

Pad Value 1000 Rx [ 0] Tx [ 0] 2000 [ 0]

Shelf Parameters :
1 [ 0] 2 [ 0] 3 [ 0] 4 [ 0] 5 [ 0] 6 [ 0]
7 [ 0] 8 [ 0] 9 [ 0] 10 [ 0] 11 [ 0] 12 [ 0]

Inbound Setup      Outbound Setup      Release Protocol
-----
Rx Ring            [N ] Tx Ring [N ]      Can't be Released [N ]
Tx Ack             [N ] Rx Ack [N ]      Re-Seize Guard Timer [ 0]
Tx Ans             [N ] Rx Ans [N ]
Decoder            [Y ] Tx Blck [N ]
No Answer on CONNECT [N ]

Electr. Set [N ]      Can Sup Inbound [Y ]      Nailed [N ]
Aux Line [N ]        Can Sup Outbound [Y ]

Find an assignment      F1 = HELP
```

ISDN Group

```
Oct 29 07:14:59 ONLN      eOn eQueue      Rev:7.00.00-b01  equeue-a
Find Next Back Add Change Delete      Print Quit
ISDN Group Modification

ISDN Group Number [ 2] Supergroup Number [0 ]

Primary D-Channel Interface ID [0 ]
Backup D-Channel Interface ID [ ]
Interface Type (P = PCM30/T = T1/V = VoIP) [T ]
ISDN Parameter Table [4 ]

Interface  Identifier No.  Starting Port  No. of Ports
1          [ 0]          [01.15.01 ]  [23]
2          [ ]          [ ]          [ ]
3          [ ]          [ ]          [ ]
4          [ ]          [ ]          [ ]
5          [ ]          [ ]          [ ]
6          [ ]          [ ]          [ ]
7          [ ]          [ ]          [ ]
8          [ ]          [ ]          [ ]
9          [ ]          [ ]          [ ]
10         [ ]          [ ]          [ ]

Find an assignment      F1 = HELP
```

ISDN Parameter

```

Oct 30 10:05:05 ONLN      eOn eQueue      Rev:7.00.00-b01  equeue-a
Find Next Back Add Change Delete      Print Quit
ISDN Parameter Modification
Number [ 4] Name [NI SERV EXPL CH ]
Protocol Variant [NIS ]
Implicit Channel Identifier [N ]
Release vs Disconnect [N ]
Trunk Release (Transfer) [N ]
Protocol Test Mode [N ]
UII Option [ ]
OSIG Name Delivery [N ]
OSIG Trunk Release (Forward) [N ]
OSIG Message Waiting [N ]
Default Values :
DNIS Type [ 0] DNIS Plan [ 0]
ANI Type [ 0] ANI Plan [ 1]
Facility [ 0] Bearer [ 0]
Find an assignment F1 = HELP
    
```

Hotline

```

Oct 30 10:07:04 ONLN      eOn eQueue      Rev:7.00.00-b01  equeue-a
Find Next Back Add Change Delete      Print Quit
Inbound Routing Modification
Number [ 17] Pilot [D801 ] Name [survey pri ] Copy From [ ]
Comment [ ] Zone [0 ]
Step Command Step Command
[1 ][ISDN ALERT ] [2 ][NULL ]
[3 ][NULL ] [4 ][NULL ]
[5 ][ROUTE DNIS, 80, 0 ] [6 ][NULL ]
[7 ][NULL ] [8 ][NULL ]
[9 ][TERMINATE ] [10][ ]
[11][ ] [12][ ]
[13][ ] [14][ ]
[15][ ] [16][ ]
[17][ ] [18][ ]
[19][ ] [20][ ]
[21][ ] [22][ ]
[23][ ] [24][ ]
[25][ ] [26][ ]
[27][ ] [28][ ]
[29][ ] [30][ ]
[31][ ] [32][ ]
Enter inbound route entry name. F1 = HELP CHANGE
    
```

Appendix: PBX Configuration Examples

Nortel (Avaya)

The following sample configurations were taken from a Nortel Option 11, LD screen 22:

```
CTYP MSDL
DNUM 8
PORT 1
DES CC_SVY
USR PRI
DCHL 19
OTBF 32
PARM RS422 DTE
DRAT 64KC
CLOK EXT
IFC NI2
    ISDN_MCNT 300
CLID OPT0
CO_TYPE STD
SIDE NET
CNEG 1
RLS ID 25
RCAP COLP NDS
T310 120
T200 3
T203 10
N200 3
N201 260
K 7
BSERV NO
```

Document Revision History

Revision	Change Description	Effective Date
0	Initial release for NICE Uptivity	2017-03-31