



CallCopy®

Innovations in Call Recording  
and Contact Center Solutions

# cc: Analytics Administration Guide, v5.2 R1

August 2013

Reference Guide

[www.callcopy.com](http://www.callcopy.com)

**Security Classification:** CallCopy Confidential.

**Distribution:** Approved internal CallCopy staff only and licensed CallCopy customers.

**Note:** Applicable non-disclosure agreements must be in force for authorization.

Revision History			
Revision	Change Description	Author	Effective Date
0	Expanded Analytics INI settings.	MBuckingham	2013-05-31
1	Added <code>commandtimeout</code> setting to INI.	MBuckingham	2013-08-13
1	<p>Added section clarifying Analytics tag deletion:</p> <p><b>Note</b> If a tag must be deleted best practice is to disable the tag, wait 10 minutes and then delete that tag. The 10minute wait will allow the tag to clear the system and not be attributed during the delete process causing a reporting error.</p> <p>Be aware deleting a tag deletes all the phrase records generated using that tag from the database. This action can drastically affect reporting. Reports that depend on historic information and comparisons will be unreliable, if that tag has been applied.</p>	BHamilton	2014-06-02

# Table of Contents

<b>Introduction</b> .....	<b>5</b>
<b>Product Technical Overview</b> .....	<b>6</b>
Languages Supported.....	8
Stereo Audio Recordings .....	8
<b>Requirements</b> .....	<b>9</b>
Hardware.....	9
Software .....	9
License.....	9
<b>Install and Configure cc: Analytics Server</b> .....	<b>10</b>
Windows Server Tasks .....	10
Installation.....	10
Register Service .....	10
Configure INI .....	10
Web Portal Tasks .....	12
Create a Server Node.....	12
Edit the CometDaemon.....	12
Add the Server to the Service Manager.....	13
Configure the Transcoder .....	13
Check the Recording Schedules .....	13
Security and Archiving .....	14
User Permission Settings.....	14
Auditing .....	14
Encryption .....	14
Archiving .....	14
<b>Configure Indexing and Searching</b> .....	<b>15</b>
Manage which Call Audio Files Are Analyzed.....	15
Create a Call Criteria Item.....	15
Edit or Delete Items .....	17
Manage Analytic Tag Groups.....	17

Manage Analytic Tags .....	17
Create a Tag .....	18
Enable/Disable/Delete a Tag.....	19
Index File Naming Conventions .....	20
<b>Analytics Reporting .....</b>	<b>21</b>
Reporting Criteria.....	21
Analytics Speech Tag Frequency.....	22
Speech Category Summary .....	23
Speech Category Trending Reporting .....	24
Speech Tag Detail .....	25
Speech Tag Exception Detail .....	25
Speech Tag Exception Summary .....	26
Speech Tag Frequency Summary .....	27
Speech Tag Trending Report.....	28
<b>About CallCopy .....</b>	<b>29</b>

# Introduction

This document is for cc: Analytics system administrators, supervisors, and management. It reviews

- Requirements, installation, and configuration information for administrators.
- Indexing and search settings that can be configured by either administrators or users. These tasks require users to understand the design of their telephone network such as gate and device usage, SQL search statements, the basic theory of speech analytics, and the information needed by supervisors and management.
- Reports generated from the speech analytics data for call center supervisors, management, and clients.

For additional information, see CallCopy's *Developing an Analytics Program*.

# Product Technical Overview

cc: Analytics is a phonetics-based speech analytics solution that identifies phonemes (i.e., the smallest unit of sound) in call recordings. United States English speech consists of 40 phonemes. United Kingdom English speech consists of 44 phonemes. The five phonemes "g r ei d ei" sound like "Grade A" or "Grey Day". cc: Analytics compares the phonemes to search key words and phrases and generates reports based on the search results.

This diagram illustrates the product's components and their interactions.

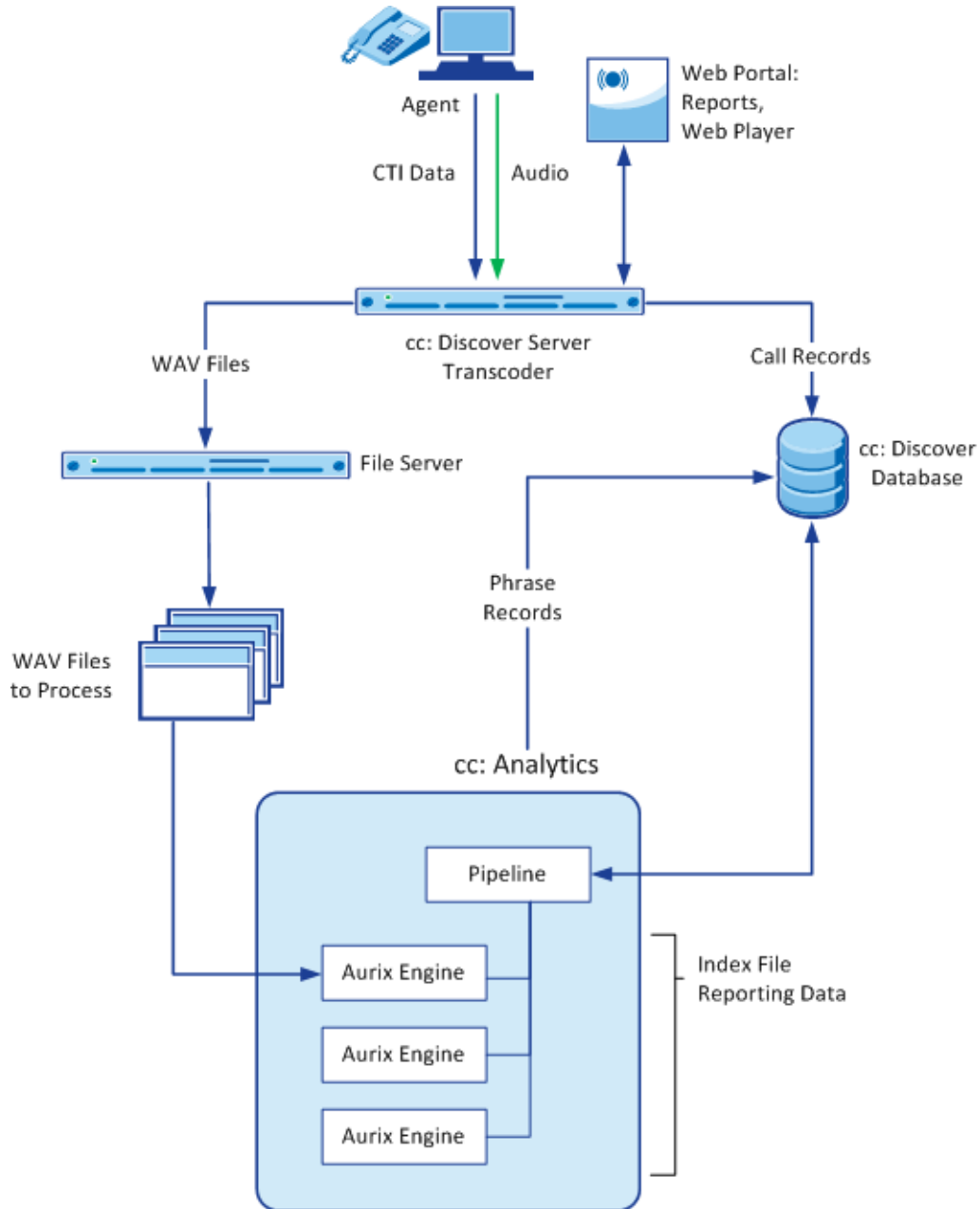

Component	Function
<b>cc: Discover Server</b>	<p>Includes the cc: Voice recorder that records the audio and creates the raw call audio files. Manages the writing of files to the file server. Creates call record files in the database.</p> <p>The Transcoder creates two call audio WAV files from the raw files. One file is used for QA and reporting; the other file is used for speech analytics.</p>
<b>cc: Discover Database</b>	<p>Stores call records associated with call audio WAV files. Used to track which call audio files are ready for processing by the speech search engine and which ones have been processed.</p> <p>Stores phrase records created by the speech search engine and associated with a call record. Phrase records contain:</p> <ul style="list-style-type: none"> <li>• Call recording ID</li> <li>• Tag ID</li> <li>• Phrase matched</li> <li>• Confidence of match</li> <li>• Start time of phrase in call record</li> <li>• End time of phrase in call record</li> <li>• Whether call audio file search/indexing has been started or completed</li> </ul>
<b>File Server</b>	Location of call audio WAV files with content that is analyzed.
<b>cc: Analytics Server</b>	<p>Pipeline component polls the database for new call audio files for processing. Selects the new call audio files that are to be indexed. Calls are checked only once to determine if they should be indexed. If the call selection criteria changes, older calls that were already checked will not be rechecked. The call selection, indexing, and searching processes are continuous. During periods of heavier call traffic, there will be more audio files waiting to be indexed and searched, and they will be processed during periods of lower call traffic.</p> <p>Manages workloads of speech search engines.</p>
<b>Aurix Speech Search Engine</b>	<p>Indexes (i.e., translates) call audio WAV files' speech into phonemes and writes the phonemes to an index file. One index file is created for each audio file per language. For example, if calls include both US English and Mexican Spanish, the engine can be configured to generate an index file for each language.</p> <p>Searches index files for analytic phrase tags and creates phrase records in the database.</p> <p>Call audio files are translated and indexed only once. If the phrase analytic tags are changed after the first search, the search engine searches the index files, not the call</p>

	<p>audio files.</p> <p>If the indexing/searching process is interrupted, the engine starts over on the audio file on which it was working when the interruption occurred.</p>
<b>Web Portal</b>	<p>cc: Analytics is administered via the cc: Discover Web Portal. The portal is also used for reporting and using the Web Player.</p>
<b>Reports</b>	<p>Reports are generated from phrase records. Reports are managed and viewed through the cc: Discover Web Portal. The Analytics server is also managed through the portal.</p>
<b>Web Player</b>	<p>Analytics data can be viewed by supervisors and managers when they play call recordings through the cc: Discover Web Player. Call recordings can be sorted using an Analytics Tag Cloud. And tags, confidence levels, and phrases appear with call recordings when they are replayed.</p>

## Languages Supported

Valid language codes are:

- 1033 – U.S. English
- 2057 – U.K. English
- 2058 – Mexico Spanish

The appropriate language packs and audio models are installed during the installation process.

## Stereo Audio Recordings

Stereo audio recordings greatly improve the performance of the analytics engine, as cross talk between recorded parties can be isolated. Within a stereo audio recording, the caller's audio is recorded on one discreet channel for the audio file, and the PBX audio is stored on the other channel. This allows the recording engine to separate the cross talk (parties talking at the same time).

Stereo recordings are available on ALL CallCopy Recording integrations with the exception of

- Avaya's DMCC and Single Step Conference via T1
- ShoreTel's TAPI wave
- eOn Service observe
- Any recording method using a service observe code via T1



# Requirements

## Hardware

Hardware requirements vary depending on the number of calls processed and data storage and retention needs. Hardware specifications are determined by the CallCopy Sales Engineering team during the sales process.

These are the hardware guidelines:

- cc: Analytics *must* be installed on its own machine. This requirement is due to the CPU usage required to index and analyze.
- A separate file server is usually needed for storing the call audio files and index files.
- cc: Discover is installed on a different server; the database, Web Portal, reporting, and other services are installed and operate from that server.
- For optimal data transfer rates, cc: Analytics should be placed on the same network switch where the cc: Discover audio files are stored.

## Software

These are the software requirements:

- Windows Server 2003 or later
- Languages require the appropriate language pack and audio models to be installed as part of the installation process.

## License

A cc: Analytics license must be purchased in addition to the cc: Discover license to enable the product features.

# Install and Configure cc: Analytics Server

## Windows Server Tasks

Perform these tasks on the Windows server hosting cc: Analytics.

### Installation

(See the *cc: Discover Installation Guide* for specific information on steps.)

cc: Analytics installation uses the cc: Discover installation files and must be done from the machine hosting the server. During this installation setup process, you must specify information for the server hosting cc: Discover, such as IP address and database name. Have this information available before you start the installation.

1. Install the CallCopy databases.
2. Run the CallCopy server setup file.
3. On the Custom Setup screen, select **Analytics** under the Server Modules.
4. Select the languages that the speech search engines will use and click **Next**.
5. Complete the remaining steps of the installer. The installation process is automated. When it completes, click **Finish**.

### Register Service

Open a Command Prompt window on the Windows server. Change to the `Recorder` directory where the CallCopy software was installed. From the directory, run the following command:

```
cc_analytics.exe -svcinst -autostart
```

If successful, the Command Prompt will print the message "Service Installed." You will be returned to the working directory prompt.

### Configure INI

The server's `cc_analytics.ini` file has to be created manually during the installation process. It must be placed in the same directory as the executable. The INI filename should always match the name of the executable it configures.

File settings are:

[settings]	<b>Analytics Server Settings</b>
ident=1	Ident of the analytics module. This is only needed in environments with multiple analytics servers.
uncmapremote0=\\servername\path uncmaplocal0=e:\path	Remote/local mapping. This is only needed if the analytics audio files are located on the analytics server itself (rather than in the regular call location) as the analytics path in the transcoder settings will be a UNC path.
purgedays=5	Days until we purge the .idx analytics file. This is needed if the analytics audio files are located on the analytics server itself (rather than in the regular call location, as the normal archive action will handle the .idx files).
maxblockpercentage=75	Maximum percentage of blocked threads before the analytics module will stop and restart. Setting this too low can cause the module to restart more often.
relatedCoreList=1,2,3	Core Ident(s) that the analytics module will analyze calls for. Only needed in multiple analytics server environments (see Ident of the analytics module settings above).
commandtimeout=	Sets the amount of time to wait (in seconds) before timing out commands. Useful in environments with high number of request timeouts or latency.
[pipeline]	<b>Analytics Processing Settings</b>
tagreadfrequencysec=180	How frequently in seconds tags are re-read. Setting this too low can cause a high number of database hits.
maxqueue size=10	Controls the number of call audio recordings that can be in the processing queue at one time. This should be set to 2 or 3 times the number of CPU cores.
workthreaddelay=30000	Time to sleep (in milliseconds) between querying for new items/items to reprocess. Setting this too low can cause a high number of database hits.

## Install and Configure cc: Analytics Server

[aurix]	Aurix Speech Search Engine Settings
<code>analyzerthreads=4</code>	Set this value to the host machine's number of CPU cores
<code>languagecode=1033,2058</code>	Language codes to be used for analytics processing. Only needed if using more than one language.
<code>localWorkDirectory=d:\aurix_temp</code>	Directory to use for local work. This is only needed if the analytics audio files are located on another server (rather than on the analytics server itself -- see Remote/local mapping settings above). When using this setting, the drive must be a local drive and should not be used for any other purpose than analytics.

cc: Analytics uses the CallCopy database. In the typical installation, the cc: Discover `settings.ini` file contains the necessary database settings and is created one directory above the `cc_analytics.exe` or in `c:\program files\callcopy`.

## Web Portal Tasks

### Create a Server Node

The Analytics machine must be added as a node in the cc: Discover Web Portal. (See the *cc: Discover Administration Manual* for additional details on this topic and the Comet Daemon.)

Follow these steps to add a Server Node:

1. In the Web Portal, go to Administration tab > System Settings > Server Nodes.
2. Click **Add Node** on the Server Node Settings.
3. Enter a friendly name for the Server Node for reference.
4. Enter the hostname or IP address of the Server Node.
5. Click **Save Node** to commit the settings.

### Edit the CometDaemon

When a server node is created, a corresponding CometDaemon is created. The CometDaemon manages connections between the cc: Discover Service Manager and the CallCopy services on the node.

1. On the Web Portal's Administration tab, click Web Portal Settings > CometDaemon.
2. Click the triangle for a server node/cometdaemon to view the settings.
3. Edit the Comet Daemon Server Settings. Most of the settings are left at the default. For the Allowed Subnets Session setting, enter the IP address of the Web Portal used to access the node for this daemon.
4. Click **Save**.

## Add the Server to the Service Manager

To add the service to the Loader configuration, follow the listed steps.

1. On the Web Portal's **Administration** tab, click Tools > Service Manager.
2. On the Service Manager page click the **Add Server** button.
3. A new line will be displayed on the page. Enter the following information:
  - Server node name created earlier.
  - IP address
4. Click the **Save**.
5. Expand the server node and click Add Application.
6. Enter the name of the service: cc\_analytics.exe. It must be entered exactly as the name EXE.
7. Specify if the Service Manager should automatically restart the application.
8. Enter any parameters that must be set for the application.
9. Click **Save**.

## Configure the Transcoder

(For additional information about the transcoder, see the *cc: Discover Administration Manual*.)

The transcoder must be configured to create WAV files for the cc: Analytics. These instructions assume that a transcoder has already been configured for normal recording file storage and that only these additional steps must be taken. Follow these steps to edit the transcoder.

1. In the cc: Discover Web Portal, go to Administration tab > Recorder Settings menu > Transcoder. The Transcoder List page shows the ones currently configured in the system.
2. Click the **Edit** (✎) icon on the right side of the transcoder to be used.
3. On the Edit Transcoder page, enter these settings:
  - **Create Analytics:** Set to Yes. The transcoder will create a very high quality stereo PCM WAV audio file for each recording in addition to the one created for QA and other needs.
  - **Analytics Keep Days:** Enter a number of days for how long the WAV files will be retained on the file server. This setting creates an archive action that will purge the files. Files can also be managed using the cc: Discover Archiver, which offers more options.
  - **Analytic Storage Path:** Enter the UNC path name of the directory to which the WAV files will be written.
4. Click **Save**.

## Check the Recording Schedules

Call recording schedules have a Speech Analytics setting. This setting must be 'Yes' in order for the stereo PCM WAV audio file to be created.

## Security and Archiving

Consider these factors when setting up and managing cc: Analytics.

### User Permission Settings

Depending on the tasks they will perform, cc: Discover users must be granted these permissions:

- **Allow Analytics View:** Allows the user to view Analytics data for played calls in the Web Player.
- **Allow Analytics Management:** Allows the user to manage Analytics configuration
- **Allow Viewing Analytics Reports:** Allows the user to run and view reports.

### Auditing

Auditing is managed through cc: Discover and the Audit Report. See the *cc: Discover Reporting Manual* for additional information.

### Encryption

WAV and index files used by the speech search engine are not encrypted – if they were, the analytics engine would not be able to read them. CallCopy recommends that these files be stored on a volume that has been encrypted.

### Archiving

The call audio WAV and index files can be archived using the cc: Discover Archiver. If index files are archived and moved, then they will not be analyzed for speech tag phrases because the search engine will no longer have access to them. See the *cc: Discover Administration Manual* for additional information.

# Configure Indexing and Searching

After the cc: Analytics server has been installed, these tasks must be completed. The settings configured in these tasks control what words and phrases the speech search engine looks for in the call audio WAV files. All of these tasks are performed in the cc: Discover Web Portal on the Administration tab's Add-Ons page.

## Manage which Call Audio Files Are Analyzed

The speech search engine uses the analytic criterion items to identify the call audio files for indexing and searching. The list criteria are compared against call records in the cc: Discover database, and the audio files associated with the selected records are translated and indexed. Call records are checked to be indexed only once.

All calls will be indexed and analyzed if no criteria are specified.

Ineffective call selection criteria can fail to identify all calls that should be analyzed or analyze calls that are not relevant to your effort. This situation can cause

- Inaccurate (too low or too high) numbers reported for compliance, process improvement, and agent assessment.
- Missed opportunities for improvement or discovery.
- Unnecessarily slow indexing and searching of calls and generation of reports.

Call selection criteria can be based on

- Language
- Client – Some clients may want information tracked or monitored while others do not.
- Purpose or function such as compliance, security, or quality training.

Call selection criteria and the number of criteria items depends on how agents are organized and calls are directed over the telephony network. For example, all Mexican Spanish calls may be received via one queue or telephone number. Or calls for a client that requires a script may be directed to specific agents.

One criteria item can be created and the expression text edited to select all needed call audio files. This approach can avoid the problem of having to check different items to see if the desired calls are being analyzed. Some users find it easier to manage multiple criteria items based on language, client, or purpose. The number of criteria items is one of many factors that affect indexing speed; there is no simple way to determine what effect the number may have on processing.

## Create a Call Criteria Item

Follow these steps to create or edit a call criteria item:

1. From the Administration tab, click Add-Ons > Analytics > Analytic Criterion List.
2. Click **Add** to create a new list.
3. On the Analytic Criterion Edit page, enter a meaningful name for the list. For example, you may have lists to identify calls for specific clients, products, or languages.

## Configure Indexing and Searching

- Select a Language Code. This field is required.

- Using the available data identifiers, enter an expression to specify the audio file selection criteria. For example, `deviceid!=0` would index all audio files. Similarly, `gate==1` would select for indexing all audio files for calls that came through Gate 1. Multiple identifiers can be used.

`recordid` represents the call record in the cc: Discover database. The other identifiers may or may not be usable, depending what data your telephony service passes to cc: Discover when calls are recorded.

The `user#` identifiers are the custom terms specified on the Terminology page. The values specified on that page do not appear in the identifiers list, so you must know what terms match which `user#`. (See the *cc: Discover Administration Manual* for additional information on the Terminology page.)

Conditional Operators		Boolean Operators	
==	Equal to	&&	Boolean and operator
!=	Not equal to		Boolean or operator
>	Greater than	( )	Parenthesis used for grouping and precedence
<	Less than		
>=	Greater than or equal to		
<=	Less than or equal to		
' or "	Both single and double quotes can be used to signify strings in expressions.		



**Note** When ANI or DNIS are used in the criterion, the numerical value should be in quotes to make it a string comparison (**dnis=="6207"**) instead of an integer comparison (**dnis==6207**). Otherwise, if the DNIS is too long, the analytics engine may stall trying to store the integer and generate errors.

- Click Save to record the list. Click Cancel to return to the Analytic Criteria page. The new entry appears on the page.

Analytic Criteria :				Add
Title	Language Code	Expression	Actions	
Client: Orange	1033 - U.S. English	gate==1 agentid>=100	Edit	Delete
Test 1	1033 - U.S. English	gate=='1' user4=='company ABC'	Edit	Delete

Pages : 1      Go To Page : 1 of 1      Go

## Edit or Delete Items



List items can be edited or deleted as needed, and the changes are applied to the call selection process after the change is made. Calls that were already checked for selection are not rechecked using the new criteria.

To edit an item, click Edit and make the necessary changes on the Analytic Criterion Edit page. Save any changes. Deleting an item completely removes it from the list.

## Manage Analytic Tag Groups

The Speech Category Summary and Speech Category Trending reports use tag groups to search for and organize data. Other reports use analytic tag groups to organize how tags appear on reports.

To manage tag groups, click Analytics > Analytic Tag Groups. On the list

- Click Add to create a new group. Enter a name for the group and click the Save icon .
- Click the Edit icon  to change the name of a group.
- Click the Delete icon  to delete a group. Deleting a group does not affect the tags in that group. If a report is based on a group, then that report will no longer get data.
- Click the red X to cancel an action.

## Manage Analytic Tags

Analytic tags specify the words and phrases the speech search engine will look for in index files. The search process is continuous as long as new calls and index files are created. After they are created, analytic tags can be enabled/disabled but not edited.

## Create a Tag

Follow these steps to create a tag:

1. Click Analytics>Analytic Tag List.
2. Click **Add**.

Analytic Tag List					
				Show All	Add
Name	Start Date	End Date	Phrases	Enabled	
Company ABC Name	8/28/2011	9/3/2011	ABC;Absolute Brilli..	Yes	
Geography	8/25/2011	8/25/2011	coral springs;pompan..	Yes	
Lead source	8/25/2011	8/25/2011	how did you hear abo..	Yes	
Product Interest	8/25/2011	8/25/2011	free estimate;save s..	Yes	
Product Name	8/28/2011	9/3/2011	Quest;tablet;ellipsi..	Yes	
Property information	8/25/2011	8/25/2011	two story;upstairs;t..	Yes	
Scheduling	8/25/2011	8/25/2011	weekend;morning;aft..	Yes	
Script Adherence	8/25/2011	8/25/2011	save with insulation..	Yes	

3. On the New Tag page, enter the following information:
  - **Tag Name:** Names should reflect the words being searched or the purpose of the search.
  - **Effective Start/End Dates:** Enter Effective Start/End Dates to have the engine search in index files for phrases in calls that occurred during an interval of time. For example, a client may have a timed promotion and wants calls for that promotion analyzed. If no Start/End Dates are specified, all index files are searched. An alternative to dates is to Enable/Disable a tag after it is created. If no Start/End Dates are entered, the tag can be enabled/disabled forever.
  - **Target Confidence:** A confidence level is a numeric percentage that represents the likelihood that the phrase identified actually matches the searched for phrase. The speech search engine assigns a confidence level to every phrase it finds. If a phrases confidence level is below the target, it is not included in the results.
  - **Criterion:** (Optional field.) Select a criterion from the Criterion List. If no criterion is specified, the tag will be applied to all calls analyzed.
  - **Group:** (Optional field.) Select a group from the Tag Groups if this tag will be associated with other tags. If no group is specified, the tag will not appear on some reports.
  - **Phrases:** Enter a search phrase. Click Add to enter additional phrases. Click the red X to delete a phrase. This field is limited to 255 characters including spaces. If additional phrases are needed, additional tags must be created.

**Note** The graphic below has approximately 230 characters. You can use Microsoft Word's Word Count function to identify the number or characters.

4. Click **Save** to create the tag.

## Enable/Disable/Delete a Tag

After a tag has been created, it can be enabled, disabled, or deleted. To perform these tasks, double-click the tag in the Analytic Tag List.

Deleting a tag deletes all the phrase records generated using that tag from the database. This action can drastically affect reporting. Reports that depend on historic information and comparisons will be unreliable. Generally, tags should be disabled rather than deleted.

If the tag is needed sometimes but not always, it should be Enabled/Disabled.

**Edit Tag** [Delete] [Cancel] [Save]

Tag Name:

Effective Start Date:

Effective End Date:

Enabled:  ▼

Target Confidence:

Criterion:  ▼

Group:  ▼

Phrase:

- 
- 
- 
- 
- 
- 
- 
- 
- 
- 
- 
- 

**Note** If a tag must be deleted best practice is to disable the tag, wait 10 minutes and then delete that tag. The 10minute wait will allow the tag to clear the system and not be attributed during the delete process causing a reporting error.

Be aware deleting a tag deletes all the phrase records generated using that tag from the database. This action can drastically affect reporting. Reports that depend on historic information and comparisons will be unreliable, if that tag has been applied.

## Index File Naming Conventions

Index files are named using these conventions:

- Files using US English: *audiofilename.idx*
- All others: *audiofilename.countrycode.idx*

# Analytics Reporting

(See the *cc: Discover Reporting Manual* for additional information about the Reporting tab's functions.)

cc: Analytics reports are accessed through the cc: Discover Web Portal. On the Reporting tab, click Printable Reports > Analytics Reporting.

The Analytics Reporting page lists the types of reports that can be created. The Date Created column shows the date that the template for the report type was created in the system.

Analytics Reporting		
Filter:	<input type="text"/>	<input type="button" value="Search"/>
Report	Description	Date Created
<a href="#">Analytics Speech Tag Frequency</a>	The Frequency with which Speech Tags Appear Over a Time Interval	5/24/2011
<a href="#">Speech Category Summary</a>	Overview of the frequency with which speech tags in particular categories appear in a time interval.	5/24/2011
<a href="#">Speech Category Trending Report</a>	Displays the speech category tag counts and how they change over time.	5/24/2011
<a href="#">Speech Tag Detail</a>	Details of the Calls in Which a Particular Speech Tags Appear	5/24/2011

## Reporting Criteria

You can use these criteria to specify the data included in a report. The criteria available vary by report.

- **Start/End Date:** Searched calls will have occurred during this date range.
- **Category List, Tag List, Tag Categories:** Tag groups
- **Tag Category, Speech Tag, Speech Tags/Tags:** Speech search tags
- **Tag/Tag Text:** Phrases in analytic tags.
- **Tag Status:** Tags can be Enabled/Disabled.
- **Agents**
- **Agent Status/Status:** Agents can be Active/Inactive.
- **Groups:** These are CallCopy groups.
- **Skill Group/Skill Group List**
- **Gates**
- **Caller's Phone#**
- **Dialed Phone#**
- **Reporting Interval:** Data can be shown for Daily, Weekly, Monthly or Yearly intervals.

## Analytics Speech Tag Frequency

The report shows the frequency that speech tag phrases/text occur over a time interval.

- **Tag Count:** The number of times that a tag text/phrase was identified. Tag Count may be greater than Number (#) Calls because a tag may occur multiple times in a call.
- **# Calls:** Number of calls in which a tag phrase occurred at least once.
- **Observed Percentage:** Percentage of calls during the specified time frame in which the tag phrase occurred.
- **Daily Occurrence:** Average number of times a tag phrase occurred per day in the specified time frame.
- **Average Confidence:** The speech search engine records a confidence level for each tag it identifies. This number averages the confidence for each tag record.



### Analytics Speech Tag Frequency

For Monday, July 25, 2011 to Thursday, August 25, 2011

Tag Name	Tag Text	Tag Count	# Calls	Observed Percentage	Daily Occurance	Avg. Confidence
Script Adherence	homeowners association	5497	5497	100.0%	171.78	78.96
Script Adherence	single family dwelling	3349	3349	60.9%	104.66	78.01
Lead source	service magic	2205	2205	40.1%	68.91	80.01
Scheduling	weekend	2192	2192	39.9%	68.50	59.06
Scheduling	morning	1101	1101	20.0%	34.41	53.62
Lead source	coupon	1101	1101	20.0%	34.41	56.83
Product Interest	free insulation upgrade	1101	1101	20.0%	34.41	50.34
Product Interest	save some money	1101	1101	20.0%	34.41	78.70
Geography	pompano beach	1101	1101	20.0%	34.41	59.33
Script Adherence	thank you for calling	1100	1100	20.0%	34.38	67.48
Property information	total square footage	1047	1047	19.0%	32.72	62.36
Scheduling	Saturday	1047	1047	19.0%	32.72	50.29
Lead source	online form	1047	1047	19.0%	32.72	51.29
Product Interest	injection foam	1047	1047	19.0%	32.72	100.00

## Speech Category Summary

The report shows an overview of the frequency with which a speech tag group/category's speech tags appear in a time interval.

- **Tag Category:** a Tag Group.
- **Tags Observe:** The number of times that a tag was identified. Tag Count may be greater than Number (#) Calls because a tag may occur multiple times in a call. (In this sample report, Script Adherence tag occurred 9946 times. In the previous sample report, Script Adherence tag phrases occurred 5497 ('homeowners association'), 3349 ('single family dwelling'), and 1100 ('thank you for calling') for a total of 9946 occurrences.
- **Calls with Tags:** Number of calls in which a tag phrase occurred at least once.
- **Observed Percentage:** Percentage of total calls selected for indexing during the specified time frame in which the tag occurred.
- **Daily Occurrence:** Average number of times a tag occurred per day in the specified time frame.
- **Average Confidence:** The speech search engine records a confidence level for each tag it identifies. This number averages the confidence for each tag record.



### Daily Speech Category Summary

For Period Encompassing Monday, July 25, 2011 to Thursday, August 25, 2011

Selected Agent Status: Active

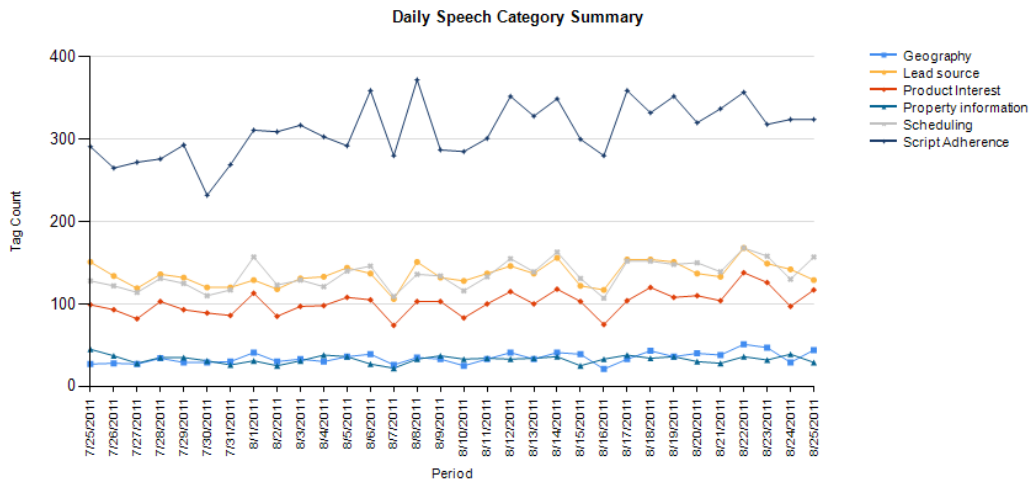

Tag Category	Tags Observerd	Calls With Tag	Observed Percentage	Daily Occurance	Avg. Tag Confidence
Geography		1101	20.0%	34.41	59.33
Lead source		4353	60.1%	136.03	67.26
Product Interest		3249	39.1%	101.53	76.10
Property information		1047	19.0%	32.72	62.36
Scheduling		4340	58.9%	135.63	55.54
Script Adherence		9946	100.0%	310.81	77.35

## Speech Category Trending Reporting

The report shows by category and time period the frequency that speech tags occur.

- **Period:** A day, week, month or other period.
- **Tag Count:** Number of times a speech tag occurred in that period's analyzed calls.
- **Total Calls Tagged:** Number of calls that were selected for speech analytics indexing for a time period.
- **Observed Percentage:** Percentage of total calls selected for indexing during the specified time frame in which the tag occurred.



### Weekly Speech Category Trending Report

For Period Encompassing Monday, July 25, 2011 to Thursday, August 25, 2011

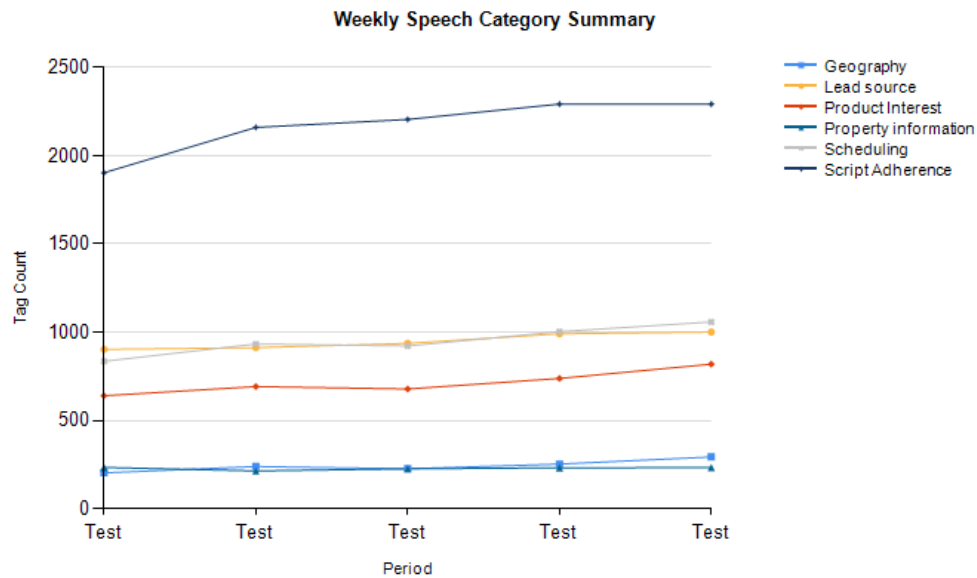

Tag Category: Geography			
Period	Tag Count	Total Calls Tagged	Observed Percentage
10/10/2011	293	1275	23.0%
10/10/2011	253	1267	20.0%
10/10/2011	226	1204	18.8%
10/10/2011	239	1184	20.2%
10/10/2011	203	1068	19.0%
	<b>1214</b>	<b>5998</b>	<b>20.2%</b>

Tag Category: Lead source			
Period	Tag Count	Total Calls Tagged	Observed Percentage
10/10/2011	768	1275	60.2%
10/10/2011	759	1267	59.9%
10/10/2011	711	1204	59.1%
10/10/2011	698	1184	59.0%
10/10/2011	669	1068	62.6%
	<b>3605</b>	<b>5998</b>	<b>60.1%</b>



## Speech Tag Detail

The report shows details of the calls in which particular speech tags appear.



### Speech Tag Detail

For Monday, July 25, 2011 to Thursday, August 25, 2011

Selected Tag Text:

<b>Record ID:</b> 42104	<b>Category:</b> Script Adherence	<b>Tag Text:</b> single family dwelling
<b>Agent:</b> ZAMORA, MABLE	<b>ANI:</b> 6142631837	<b>DNIS:</b> 8881234567
<b>Time:</b> 8/25/2011 11:09 PM	<b>Duration:</b> 00:03:57	<b>Gate:</b> Customer Care
<b>Section Start:</b> 85	<b>Section End:</b> 86	<b>Confidence:</b> 65.4%
<b>Call Direction:</b> Inbound	<b>Device:</b> 4038	<b>Channel:</b> 73
<b>Target Confidence:</b> 50.0%		
<b>Record ID:</b> 42104	<b>Category:</b> Script Adherence	<b>Tag Text:</b> homeowners association
<b>Agent:</b> ZAMORA, MABLE	<b>ANI:</b> 6142631837	<b>DNIS:</b> 8881234567
<b>Time:</b> 8/25/2011 11:09 PM	<b>Duration:</b> 00:03:57	<b>Gate:</b> Customer Care
<b>Section Start:</b> 137	<b>Section End:</b> 138	<b>Confidence:</b> 68.5%
<b>Call Direction:</b> Inbound	<b>Device:</b> 4038	<b>Channel:</b> 73
<b>Target Confidence:</b> 50.0%		
<b>Record ID:</b> 42104	<b>Category:</b> Scheduling	<b>Tag Text:</b> weekend
<b>Agent:</b> ZAMORA, MABLE	<b>ANI:</b> 6142631837	<b>DNIS:</b> 8881234567
<b>Time:</b> 8/25/2011 11:09 PM	<b>Duration:</b> 00:03:57	<b>Gate:</b> Customer Care
<b>Section Start:</b> 234	<b>Section End:</b> 234	<b>Confidence:</b> 56.3%
<b>Call Direction:</b> Inbound	<b>Device:</b> 4038	<b>Channel:</b> 73
<b>Target Confidence:</b> 50.0%		

## Speech Tag Exception Detail

The report shows a list of calls in which specific speech tags did NOT occur. This report is useful for script adherence or policy compliance.



### Speech Tag Exception Detail

For Period of Monday, July 25, 2011 to Thursday, August 25, 2011

Selected Skill Groups: East Agents

Speech Tag Name	Agent Name	Record ID	Time Recorded	Call Duration
Company ABC Name	ANTHONY, LAWANDA	<a href="#">5921</a>	7/27/2011 2:27 PM	372.00
Company ABC Name	ANTHONY, LAWANDA	<a href="#">17116</a>	8/5/2011 1:05 PM	372.00
Company ABC Name	ANTHONY, LAWANDA	<a href="#">39895</a>	7/25/2011 7:45 AM	372.00
Company ABC Name	BAUER, GUADALUPE	<a href="#">1080</a>	8/7/2011 2:20 PM	464.00
Company ABC Name	BAUER, GUADALUPE	<a href="#">6546</a>	8/22/2011 7:41 PM	464.00
Company ABC Name	BAUER, GUADALUPE	<a href="#">28107</a>	8/18/2011 12:40 AM	255.00
Company ABC Name	BAUER, GUADALUPE	<a href="#">46611</a>	8/21/2011 6:23 AM	237.00
Company ABC Name	DANIEL, OFELIA	<a href="#">1101</a>	7/25/2011 11:15 PM	464.00
Company ABC Name	DANIEL, OFELIA	<a href="#">6860</a>	8/17/2011 1:35 AM	491.00
Company ABC Name	DANIEL, OFELIA	<a href="#">25376</a>	8/16/2011 11:32 AM	372.00
Company ABC Name	ELLISON, LESLEY	<a href="#">14278</a>	7/28/2011 7:17 PM	491.00
Company ABC Name	ELLISON, LESLEY	<a href="#">49634</a>	8/25/2011 12:49 AM	491.00

## Speech Tag Exception Summary

The report summarizes the number of calls that did and did not have specified speech tags. This report is useful with other exception reports for tracking script adherence or policy compliance.

- The blue bar represents the number of calls with the speech tag.
- The amber bar represents the number of call without the speech tag.
- The red bar represents the percentage of calls with the speech tag.



### Speech Tag Exception Summary

For Period of Monday, July 25, 2011 to Thursday, August 25, 2011

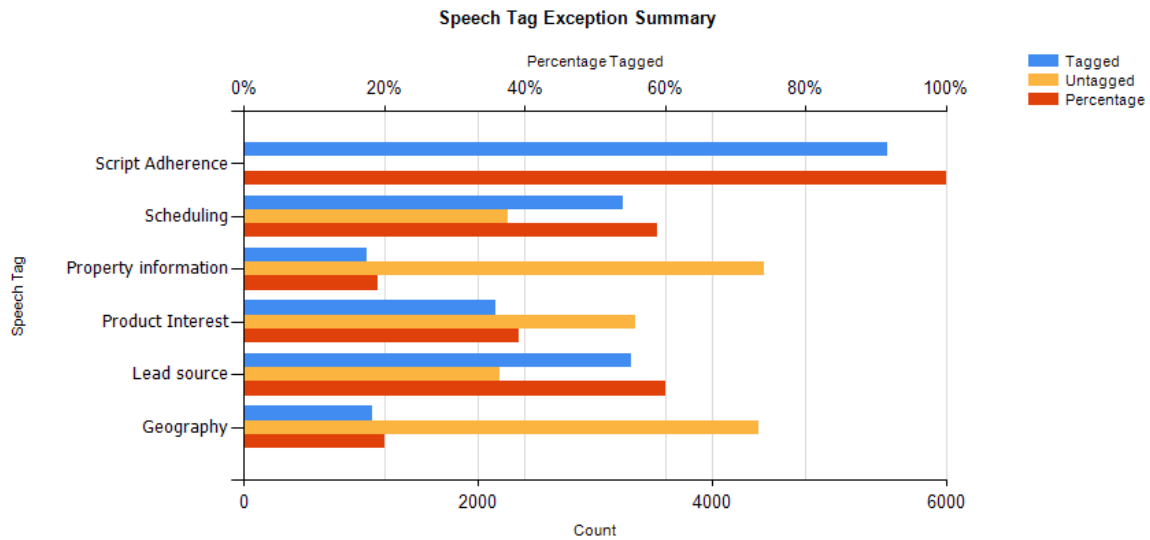

Speech Tag Name	Number of Calls Tagged	Number of Calls Untagged	Percent of Calls Tagged
Geography	1101	4396.00	20.0%
Lead source	3306	2191.00	60.1%
Product Interest	2148	3349.00	39.1%
Property information	1047	4450.00	19.0%
Scheduling	3239	2258.00	58.9%
Script Adherence	5497	0.00	100.0%

# Speech Tag Frequency Summary

The report shows the frequency with which speech tags appear over a time interval.

- **Tag Category:** Tag group
- **Speech Tag:** Speech tag
- **Tags Observed:** The number of times that a tag was identified. Tag Count may be greater than Number (#) Calls because a tag may occur multiple times in a call.
- **Calls with Tag:** Number of calls in which a tag phrase occurred at least once.
- **Observed Percentage:** Percentage of total calls selected for indexing during the specified time frame in which the tag occurred.
- **Daily Occurrence:** Average number of times a tag occurred per day in the specified time frame.
- **Average Confidence:** The speech search engine records a confidence level for each tag it identifies. This number averages the confidence for each tag record.

## Daily Speech Tag Frequency Summary

For Period Encompassing Monday, July 25, 2011 to Thursday, August 25, 2011

Selected Agent Status: Active  
Selected Tag Status: Active

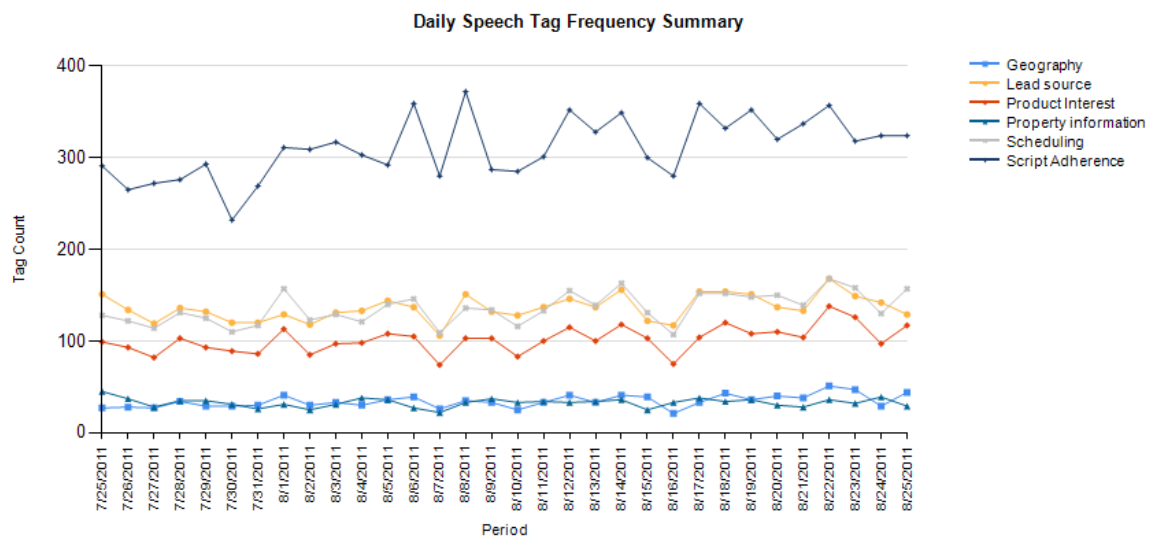

Tag Category	Speech Tag	Tags Observed	Calls with Tag	Observed Percentage	Daily Occurrence	Avg. Tag Confidence
Geography	Geography	1101	1101	20.0%	34.41	59.33
Lead source	Lead source	4353	4353	79.2%	136.03	62.70
Product Interest	Product Interest	3249	3249	59.1%	101.53	76.35
Property information	Property information	1047	1047	19.0%	32.72	62.36
Scheduling	Scheduling	4340	4340	79.0%	135.63	54.32
Script Adherence	Script Adherence	9946	9946	180.9%	310.81	74.80

## Speech Tag Trending Report

The report shows the speech tag counts for a selected category and how they change over a time interval.

- **Period:** A day, week, month time period.
- **Tag Text:** Text/phrases specified for a tag.
- **Calls Tagged:** Number of calls with the specified speech tag phrase/text.
- **Total Calls:** Number of calls selected for speech analytics.
- **Observed Percentage:** Number of calls tagged/Total Call



### Weekly Speech Tag Trending Report

For Period Encompassing Monday, July 25, 2011 to Thursday, August 25, 2011

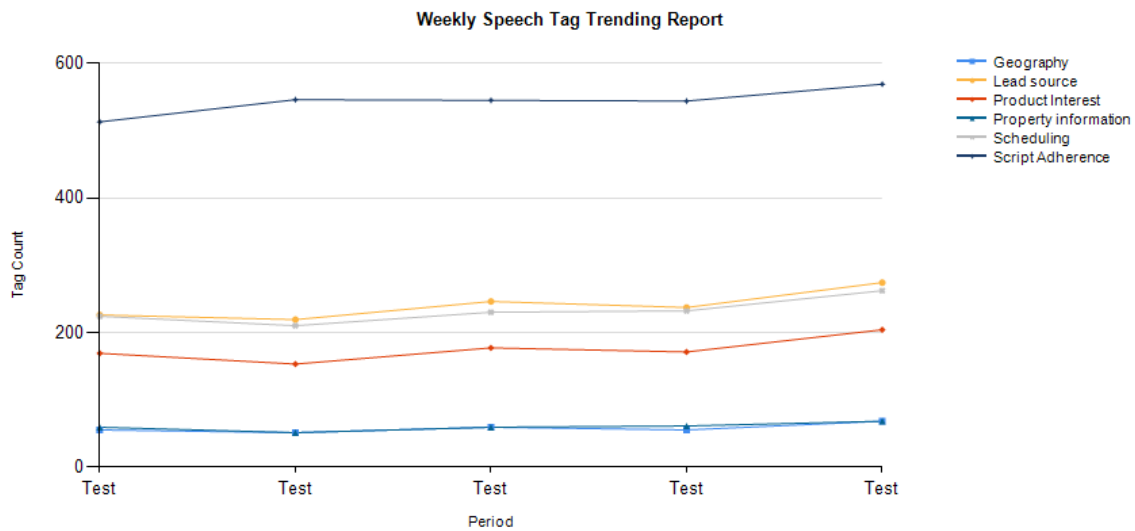

Category:		Geography			
Tag Name:		Geography			
Period	Tag Text	Calls Tagged	Total Calls	Observed Percentage	
Test	Geography	55	283	19.4%	
Test	Geography	51	291	17.5%	
Test	Geography	59	301	19.6%	
Test	Geography	55	299	18.4%	
Test	Geography	68	323	21.1%	
<b>Total:</b>		<b>288</b>	<b>1497</b>	<b>19.2%</b>	

Category:		Lead source			
Tag Name:		Lead source			
Period	Tag Text	Calls Tagged	Total Calls	Observed Percentage	
Test	Lead source	167	283	59.0%	
Test	Lead source	168	291	57.7%	

# About CallCopy

CallCopy, a leading provider of innovative call recording and contact center solutions, is dedicated to ensuring the highest standards of customer and employee satisfaction. The award-winning, enterprise-proven cc: Discover suite delivers advanced call recording, screen capture, quality management, speech analytics, performance management, customer survey and workforce management capabilities to organizations of all sizes and industries across the globe.

CallCopy empowers these organizations to gather business intelligence, which is leveraged to maximize operational performance, reduce liability, achieve regulatory compliance and increase customer satisfaction.

For more information, visit [www.callcopy.com](http://www.callcopy.com).